

# EAE/ASE recommendations for the use of echocardiography in new transcatheter interventions for valvular heart disease

Jose L. Zamorano<sup>1\*†</sup>, Luigi P. Badano<sup>2</sup>, Charles Bruce<sup>3</sup>, Kwan-Leung Chan<sup>4</sup>, Alexandra Gonçalves<sup>5</sup>, Rebecca T. Hahn<sup>6</sup>, Martin G. Keane<sup>7</sup>, Giovanni La Canna<sup>8</sup>, Mark J. Monaghan<sup>9</sup>, Petros Nihoyannopoulos<sup>10</sup>, Frank E. Silvestry<sup>7</sup>, Jean-Louis Vanoverschelde<sup>11</sup>, and Linda D. Gillam<sup>12‡</sup>

**Document Reviewers: European Association of Echocardiography (EAE): Alec Vahanian, Vito Di Bello, Thomas Buck; American Society of Echocardiography (ASE): The ASE Guidelines and Standards Committee and the ASE Board of Directors**

<sup>1</sup>University Clinic San Carlos, Madrid, Spain; <sup>2</sup>University of Padua, Padua, Italy; <sup>3</sup>Mayo Clinic, Rochester, MN, USA; <sup>4</sup>University of Ottawa Heart Institute, Ottawa, Ontario, Canada; <sup>5</sup>University of Porto, Porto, Portugal; <sup>6</sup>Columbia University Medical Center, New York, NY, USA; <sup>7</sup>University of Pennsylvania School of Medicine, Philadelphia, PA, USA; <sup>8</sup>San Raffaele Scientific Institute, Milan, Italy; <sup>9</sup>King's College Hospital, London, UK; <sup>10</sup>Imperial College London, Hammersmith Hospital, NHLI, London, UK; <sup>11</sup>Cliniques Universitaires Saint-Luc, Brussels, Belgium; and <sup>12</sup>Gagnon Cardiovascular Institute, Morristown, NJ, USA

Received 17 May 2011; accepted after revision 19 May 2011

The introduction of devices for transcatheter aortic valve implantation, mitral repair, and closure of prosthetic paravalvular leaks has led to a greatly expanded armamentarium of catheter-based approaches to patients with regurgitant as well as stenotic valvular disease. Echocardiography plays an essential role in identifying patients suitable for these interventions and in providing intra-procedural monitoring. Moreover, echocardiography is the primary modality for post-procedure follow-up. The echocardiographic assessment of patients undergoing transcatheter interventions places demands on echocardiographers that differ from those of the routine evaluation of patients with native or prosthetic valvular disease. Consequently, the European Association of Echocardiography in partnership with the American Society of Echocardiography has developed the recommendations for the use of echocardiography in new transcatheter interventions for valvular heart disease. It is intended that this document will serve as a reference for echocardiographers participating in any or all stages of new transcatheter treatments for patients with valvular heart disease.

## Keywords

Transcatheter aortic valve implantation • Transcatheter mitral repair • Transcatheter paravalvular leak closure  
• Echocardiography

## Introduction

Until recently, transcatheter therapy for valvular heart disease was limited to balloon valvuloplasty. However, the introduction of devices for transcatheter aortic valve implantation (TAVI), mitral repair, and closure of prosthetic paravalvular leaks has led to a greatly expanded armamentarium of catheter-based approaches to patients with regurgitant as well as stenotic valvular disease.

Echocardiography plays an essential role in identifying patients suitable for these interventions and in providing intra-procedural

monitoring. Moreover, echocardiography is the primary modality for post-procedure follow-up. The echocardiographic assessment of patients undergoing transcatheter interventions places demands on echocardiographers that differ from those of the routine evaluation of patients with native or prosthetic valvular disease. Consequently, anticipating growing use of transcatheter valve therapies and, along with it, an expanding need for informed echocardiographic evaluation, the European Association of Echocardiography in partnership with the American Society of Echocardiography has developed these recommendations. It is intended that this document

\* Corresponding author. Tel/fax: +34 91 544 8940, Email: zamorano@secardiologia.es

† Writing Group chair (EAE).

‡ Writing Group co-chair (ASE); writing group members are listed in alphabetical order.

Published on behalf of the European Society of Cardiology. All rights reserved. © The Author 2011. For permissions please email: journals.permissions@oup.com

will complement the earlier ASE guideline for Echocardiography-guided interventions<sup>1</sup> and will serve as a reference for echocardiographers participating in any or all stages of new transcatheter treatments for patients with valvular heart disease.

## Transcatheter aortic valve implantation

TAVI is a new technique with the potential for transforming the treatment of patients with aortic stenosis (AS). The technology is currently being evaluated in patients with severe symptomatic AS who are at high risk for conventional open heart surgery or considered inoperable. In the future, however, there may be expanded indications for TAVI. At this stage of development, TAVI remains a challenging technology that requires a multidisciplinary team approach involving interventional cardiologists, surgeons, anaesthesiologists, and imaging specialists. Imaging indeed plays a central role in successfully implementing TAVI as it is needed at each step of the procedure including patient selection, choice of procedural access, prosthetic choice and sizing, procedural guidance, and detection of early and late complications.

### Introduction

In April 2002, Cribier et al.<sup>2</sup> reported the first successful implantation of a bovine pericardial bioprosthesis mounted within a stainless steel balloon-expandable stent in a patient with severe AS who presented in cardiogenic shock. After this first-in-man implantation, the procedure was attempted on a compassionate basis in several other patients with an equine pericardial modification of the original valve design. Valve placement was initially done via an antegrade transseptal approach. This was a challenging procedure, owing to the need for transseptal puncture, the tortuous navigation of the valve assembly across the mitral and aortic valves, and the guide wire interaction with the mitral valve apparatus, which often caused severe mitral regurgitation (MR). These limitations prompted technical improvements in the size and steerability of the delivery system which allowed for the development of the more practical retrograde transfemoral approach. Additional changes in the structure of the valve (processed bovine pericardium and extended skirt height) resulted in the Edwards SAPIEN™ valve. For patients with poor peripheral vascular access, a transapical approach was subsequently developed.<sup>3</sup> The SAPIEN™ valve received European approval (CE Mark) for both transfemoral and transapical approaches in 2007.

In 2005, Grube et al.<sup>4</sup> first reported the use of a different type of percutaneous valve system designed for the aortic position, the CoreValve™ system. This received CE mark in 2007. The CoreValve™ valve is self-expandable and offers the advantage of being self-centring and partially repositionable.

Expansion and refinement of transcatheter approaches for aortic valve implantation is an area of active research and development with a variety of devices in the pipeline, but only the SAPIEN™ and CoreValve™ valves have been approved. Both have been reported to have excellent flow characteristics with core-lab-adjudicated mean aortic valve area (AVA) and mean gradient at 1 year of 1.5 cm<sup>2</sup> and 11 mmHg, respectively, for the SAPIEN™ valve,<sup>5</sup> and

site-reported mean gradients of 8 mmHg at 1 year for the CoreValve™.<sup>6</sup>

## Current status of Edwards SAPIEN™ and CoreValve™ systems in Europe and North America

European approval of both the Edwards SAPIEN™ and CoreValve™ valves was granted in 2007, in the absence of a randomized trial and depending on data from a series of relatively small studies and registry reports. A newer generation modification of the Edwards valve, the Edwards SAPIEN™ XT, received CE mark in 2010. Both the SAPIEN™ and CoreValve™ valves are available in Canada for compassionate use for the treatment of patients with severe AS who are considered inoperable or at very high surgical risk. Although neither of these valves has been approved for commercial or compassionate use in the USA, the Edwards SAPIEN™ valve was approved for use as an investigational device in a pivotal trial (PARTNER US; Placement of AORTic traNscatheterER valves) and results were recently published.<sup>5,7</sup> A US randomized multicentre trial evaluating the CoreValve™ valve is underway, and a US randomized multicentre trial evaluating the SAPIEN™ XT valve has been approved.

### Transcatheter aortic valve prostheses

Echocardiographers need to be familiar with the design of the two available prostheses, the Edwards SAPIEN™ valve and the Medtronic CoreValve™ valve. Each valve has specific characteristics and different aortic anatomic requirements. Thus, a precise echocardiographic evaluation is essential for appropriate patient selection

The Edwards SAPIEN™ valve is a balloon-expandable valve based on Cribier's original design.<sup>2</sup> The current-generation valve is composed of a cylindrical stainless steel balloon-expandable stent into which three symmetric leaflets made of bovine pericardium are mounted (Figure 1A). The stent also has a polyethylene terephthalate fabric skirt that decreases paravalvular leaks. The valve is available in two sizes, oversized in relation to the aortic annulus to reduce the degree of paravalvular regurgitation (PVR); a 23 mm prosthesis for transverse aortic annular diameters of 18–21 mm (measured at the level of aortic cusp insertion) and a 26 mm prosthesis for aortic annular diameters of 22–25 mm. The valve may be deployed via a transfemoral or transapical route. Because of the large valve size, sheath size is a significant factor with respect to procedural complications.

A newer generation valve, the Edwards SAPIEN™ XT as well as NovaFlex™ transfemoral and Ascendra™ transapical delivery systems, has recently received CE mark in Europe. The delivery system has a smaller calibre (18 F) and the valve stent is thinner and comprised a cobalt-chromium frame (Figure 1B), providing improved radial strength and enhanced circularity.

### Transfemoral 'retrograde' delivery technique

Transfemoral placement is undertaken using an introducer sheath with an internal calibre of 22 or 24 F depending on the valve size.<sup>8,9</sup> After femoral artery vascular access is achieved, a balloon aortic valvuloplasty is performed during rapid right ventricular pacing. Subsequently, the stented valve, crimped onto the delivery

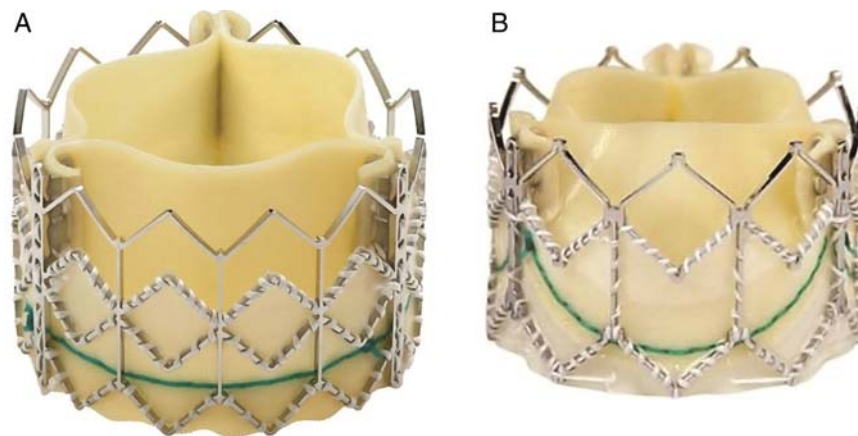

**Figure 1** (A) The Edwards SAPIEN™ valve and (B) the Edwards SAPIEN-XT™ valve.

balloon, is advanced under fluoroscopic guidance, using a manually deflectable-guiding catheter that facilitates atraumatic navigation of the valve around the aortic arch and centring the guide wire through the native valve commissures. The valve is then positioned in a subcoronary position using fluoroscopic and/or transoesophageal echocardiography (TEE) guidance. Once the proper position has been achieved, the valve is deployed under rapid right ventricular pacing.

#### Transapical delivery technique

This more invasive approach requires an anterolateral mini-thoracotomy, ideally performed in a hybrid operative suite. Prior to the creation of a sterile field, the location of the apex is identified by palpation and confirmed by transthoracic echocardiography (TTE). Subsequently, the pericardium is opened near the left ventricular (LV) apex, a sheath is inserted directly into the LV cavity, and a guide wire is used to cross the aortic valve under fluoroscopic and TEE guidance. Aortic balloon valvuloplasty is then performed during rapid pacing after which the 26 F sheath is inserted permitting deployment of the prosthetic valve.

#### Procedural success and early clinical outcomes

Recent preliminary data reported from the SAPIEN™ Aortic Bioprosthesis European Outcome SOURCE Registry,<sup>10</sup> a clinical post-commercialization 'real-world' registry of patients undergoing TAVI with the Edwards SAPIEN™ valve, included 1038 consecutive patients (575 apical and 463 transfemoral) from 32 sites. Overall short-term procedural success was 93.8%. The incidence of valve embolization and coronary obstruction was 0.6 and 0.3%, respectively. Thirty-day mortality was 6.3% in transfemoral patients and 10.3% in transapical patients. Illustrating the steep learning curve with the procedure, Webb *et al.*,<sup>11</sup> reporting a single institution's experience of 113 patients noted that mortality fell from 12.3% in the initial half to 3.6% in the second half of the experience. In the report of 1-year results for Cohort B of the PARTNER trial (inoperable patients randomized to either TAVI or medical therapy including valvuloplasty), 1-year survival was 50.7% in the TAVI arm vs. 30.7% in the medical arm.<sup>5</sup> This is the only randomized trial to date comparing



**Figure 2** The CoreValve™ ReValving system.

TAVI with surgery or medical therapy. The results of Cohort A [699 high-risk surgical patients, Society of Thoracic Surgeons (STS) score  $\geq 10$  or a predicted operative mortality  $\geq 15\%$ , randomized to either surgery or transfemoral/transapical valve implantation, depending on vascular access] were recently presented,<sup>7</sup> showing non-inferiority with regard to mortality at 1 year. In both PARTNER and the 1-year SOURCE reports, vascular complications at the time of intervention were associated with reduced survival.

'The CoreValve™ ReValving system' prosthesis consists of porcine pericardial tissue sewn to form a trileaflet valve mounted within an asymmetrical self-expanding nitinol frame (Figure 2). Once deployed, the point of coaptation of the leaflets is supra-annular. The current-generation nitinol frame is  $>50$  mm in length and is hourglass-shaped. The lower portion of the frame affixes the valve to the LV outflow tract (LVOT) and

has the greatest radial strength, but care must be taken not to impinge on the anterior mitral leaflet. The mid-portion of the prosthesis has a constrained waist that must be deployed at the level of the sinuses of Valsalva and the coronary ostia, so as not to jeopardize coronary flow. It has a high radial force to firmly anchor the prosthesis and prevent migration or paravalvular leakage. Finally, the upper section (outflow) has the lowest radial force and is designed to fix and stabilize the prosthesis in the ascending aorta.

The prosthetic size is determined by the external diameter of the ventricular end; the 26 and 29 mm prostheses have mid-portion diameters of 22 and 24 mm, aortic end-diameters of 40 and 43 mm, and prosthetic lengths of 55 and 53 mm, respectively. The 26 mm prosthesis is designed for patients with aortic annular diameters of 20–23 mm, whereas the 29 mm prosthesis is suitable for patients with 24–27 mm aortic annuli. However, the design of this prosthesis, with a broader upper segment to secure it to the ascending aortic wall, mandates that the height and width of the aortic sinuses and the ascending aortic diameter be carefully measured. In the presence of ascending aortic diameters >45 mm and/or aortic annular diameters <20 or >27 mm, this device should not be implanted. The delivery system of the CoreValve™ has evolved from an initial 25 F to the current 18 F device, which allows completely percutaneous arterial access and the possibility of avoiding general anaesthesia.

### CoreValve™ delivery technique

The CoreValve™ is designed for retrograde delivery through arterial access, although there are case reports of deployment using a transapical route.<sup>12</sup> Vascular access can be obtained with or without standard surgical cut down of the common iliac, common femoral, or subclavian arteries. The procedure can be performed under general anaesthesia or with local anaesthesia in combination with mild systemic sedation/analgesia. After femoral artery access has been secured, a balloon aortic valvuloplasty of the calcified stenotic aortic valve is performed during rapid right ventricular pacing. After this valvular dilation, the prosthesis is deployed and implanted retrogradely over a stiff guide wire. Post-dilation of the CoreValve™ prosthesis can be performed at the discretion of the operator depending on the perceived proper placement of the device angiographically and the degree of aortic regurgitation.

### Procedural success and early clinical outcomes

Recently, Piazza et al.<sup>13</sup> reported procedural success and outcomes at 30 days in 636 patients with symptomatic AS, who underwent implantation with the third-generation CoreValve™ during the first year of the multicentre expanded CoreValve™ evaluation registry. Procedural success was achieved in 97.2% patients. Procedural death occurred in 1.5% of the patients. The combined incidence of procedural death, myocardial infarction, and stroke was 2.5%. At 30 days, all-cause mortality was 8%, one half of these deaths being judged to be procedure-related. Permanent pacemaker implantation was needed in 9.3% of the patients. TTE performed prior to discharge demonstrated a significant reduction in mean transaortic pressure gradients (from  $49 \pm 14$  to  $3 \pm 2$  mmHg).

## Patient selection for transcatheter aortic valve implantation

Appropriate screening and patient selection, based on clinical criteria and careful analysis of cardiovascular anatomy, is crucial for the success of TAVI. Selection of candidates is complex and involves a multidisciplinary team evaluation and the use of multiple imaging modalities in order to fully delineate the anatomy of the aortic valve, aorta, and peripheral vasculature. Although not the focus or scope of these recommendations, the clinical criteria for patient selection are briefly described below.

### Clinical criteria

The consensus statement on TAVI from 2008 recommends the use of this procedure in high-risk patients or those with contraindications for surgery.<sup>14</sup> Risk evaluation is usually performed using the Logistic European System for Cardiac Operative Risk Evaluation (EuroSCORE) and/or the STS Predicted Risk of Mortality Score. High surgical risk is defined by a logistic EuroSCORE of  $\geq 15$ –20% or an STS mortality risk score of  $\geq 10\%$ . However, these scores have clear limitations and their predictive capacity may be reduced in high-risk patients who represent a small proportion of the population from which the scores were constructed. Moreover, the suitability of these scores for assessing risk during TAVI has been questioned<sup>15</sup> since co-morbidities that are less significant for TAVI considerably increase the risk of surgical aortic valve replacement (AVR), especially in elderly patients.

Patient characteristics that might favour TAVI over AVR include prior cardiac surgery with grafts and/or adhesions, previous chest radiation therapy, porcelain aorta, liver cirrhosis, pulmonary hypertension, right ventricular failure, or marked patient frailty.<sup>16,17</sup> Nevertheless, TAVI is not recommended for patients whose life expectancy is less than 1 year or who cannot expect significant improvement in quality of life.<sup>14</sup> In clinically suitable patients for TAVI, the evaluation of the size, tortuosity, and calcification of peripheral arteries by angiography, multislice computed tomography (MSCT), or magnetic resonance imaging assists in choosing between transfemoral and transapical approaches.<sup>18</sup>

### Echocardiographic evaluation

Echocardiography is critical in the assessment of candidates for TAVI, providing both anatomic and haemodynamic information.

#### Transthoracic echo

Transthoracic echo plays a key role in establishing the presence of severe AS with Doppler assessment of peak and mean transaortic gradients as well as AVA calculation by the continuity equation.<sup>19</sup> According to the current guidelines, severe AS is defined by an AVA of  $\leq 1$  cm<sup>2</sup> ( $<0.6$  cm<sup>2</sup>/m<sup>2</sup>) or a mean aortic valve gradient of  $\geq 40$  mmHg.<sup>20,21</sup> However, the requirements for SAPIEN™ implantation as defined in the PARTNER trial are a valve area of  $<0.8$  cm<sup>2</sup>, a peak transvalvular velocity of  $\geq 4$  m/s and/or a mean gradient of  $\geq 40$  mmHg, targeting patients with particularly severe (critical) stenosis.

Although a full discussion of the pitfalls in diagnosing severe AS is beyond the scope of this document, two groups where the diagnosis of severe AS may be challenging should be noted. Patients



may present with low gradients, despite valve areas within the severe range in the presence of severe LV systolic dysfunction. This may pose the dilemma of distinguishing between true severe AS and pseudo-severe AS in which reduced LV systolic function contributes to the reduction in calculated valve area. Dobutamine stress echocardiography has been shown to distinguish between the two and provide useful information concerning contractile reserve.<sup>22</sup> Additionally, attention has recently been focused on patients with low gradients and normal LV ejection fraction but low flow AS<sup>23</sup> for whom calculation of projected valve area under normal flow states may be useful. Cardiac catheterization is no longer recommended for determining the severity of AS, except in exceptional cases with conflicting data on echocardiography.<sup>20,21</sup>

Once the diagnosis of severe valvular AS is clear, echocardiography must determine whether the patient's anatomy is suitable for TAVI. Using TTE, assessing the annular dimension and detailed anatomic characteristics of the aortic valve, including the number, mobility, and thickness of cusps, as well as the extent and distribution of calcification should be described. Currently, bicuspid aortic valve is an exclusion criterion for TAVI because an elliptical valvular orifice may predispose to an increased risk of incomplete and incorrect deployment of the aortic prosthesis. Moreover, the risk of aortic complications, such as spontaneous aortic dissection, may be increased, due to abnormal arterial wall structure.<sup>17</sup> That said, cases of successful TAVI in bicuspid AS have been reported.<sup>18</sup>

Accurate sizing is critical to TAVI procedural success. Annular dimension is a key measurement as this determines eligibility for TAVI and guides the selection of valve type and size. Prior sections have described criteria for selecting valve size based on aortic annular, sinus of Valsalva, and ascending aortic dimensions.

Undersizing the prosthesis can result in device migration or significant paravalvular aortic regurgitation. Moreover, even if severe procedural complications do not occur, prosthesis mismatch may result. Oversizing predisposes to complications related to vascular access or to difficulties when crossing the native aortic valve with the delivery system. There is also the risk of under-expansion with consequent redundancy of leaflet tissue, creating folds that will generate regions of compressive and tensile stress that may cause central aortic regurgitation or reduction in valve durability.<sup>24</sup>

Annular diameter is typically measured in systole, in a parasternal long-axis view, zoomed on the LVOT. The measurement is taken at the point of insertion of the aortic valve cusps, from tissue–blood interface to blood–tissue interface—trailing edge to leading edge (Figure 3A), regardless of the degree of calcification of the aortic cusps. When transthoracic two-dimensional (2D) echocardiographic measurements of the annulus are uncertain, particularly if measurements are near critical cut-offs for valve selection or if calcification extends from the aortic valve onto either the anterior mitral leaflet or the septum, TEE ± 3D evaluation may be necessary. The resolution of 3D TTE is currently inadequate for assistance in annular measurements in most subjects.

LV and right ventricular dimensions and function, aortic regurgitation, and the structure and function of the other valves should be evaluated.<sup>25</sup> The presence of haemodynamically significant LVOT obstruction due to basal septal hypertrophy represents a

contraindication as septal hypertrophy is a potential cause of prosthesis displacement during or after implantation. These patients are potential candidates for myomectomy. The presence of an LV thrombus must be excluded, as it represents a contraindication to the procedure. The presence of a patch in the LV as well as significant pericardial calcification is a contraindication for TAVI using the transapical approach.<sup>14</sup>

#### *Transoesophageal echo*

TEE is recommended prior to TAVI if there are any concerns about the assessment of the aortic root anatomy, aortic annular size, or number of cusps. Since patients with symptomatic AS tolerate hypotension poorly, sedation should be performed carefully with an emphasis on effective topical anaesthesia.

The aortic root is a direct continuation of the LVOT and extends from the basal attachment of the aortic valvular cusps to the level of the sinotubular junction.<sup>24</sup> The diameter of the root varies considerably along its length, but it is the annular diameter at the level of the basal attachment of the aortic valve cusps, measured in systole, that dictates the size of the prosthesis, irrespective of the type of the valve inserted (Figure 3B).

TEE aortic annular measurements correlate well with TTE, although the latter underestimates TEE-measured aortic annular size with a mean difference of 1.36 mm (95% confidence interval, 1.75–4.48 mm).<sup>26</sup> There is concern that the assumption of annular circularity made by 2D echo may result in erroneous annular measurements in patients whose annuli are more oval-shaped. However, a strategy based on 2D TEE measurements has been shown to provide good clinical results when compared with MSCT.<sup>27</sup>

Currently, there is no consensus regarding the gold standard imaging technique for annular sizing, although, from a practical perspective, TTE performs this task adequately in most patients.

#### *Transoesophageal echocardiography protocol*

The pre-procedure TEE evaluation may be performed as part of screening or as the initial step of intra-procedural monitoring.

Using the long-axis view (usually around 110–130°), the LVOT and upper septum should be assessed since the presence of a sub-aortic septal bulge may create an obstacle to proper seating of the aortic prosthesis.<sup>24</sup>

Using short-axis views, the opening of the aortic valve should be classified as central or eccentric and the severity, location, and symmetry of aortic valve calcification accurately described. During TAVI, the prosthesis anchors according to the resistance of the subleaflet tissue. During implantation, the native cusps are crushed against the aortic wall and the differences in the tension–force across the valve may cause asymmetric deployment of the prosthesis and contribute to the risk of compression of the coronary arteries during TAVI.<sup>8</sup>

In order to minimize the risk of coronary occlusion, it is essential to know the distance from the aortic annulus to the ostia of the coronary arteries and to compare this with the length of the cusps measured in a long-axis view. Although the cusps are typically shorter than the annular-ostial distances, patients in whom the cusp length exceeds the annular-ostial distances are at risk of ostial coronary occlusion when the valve is deployed and the

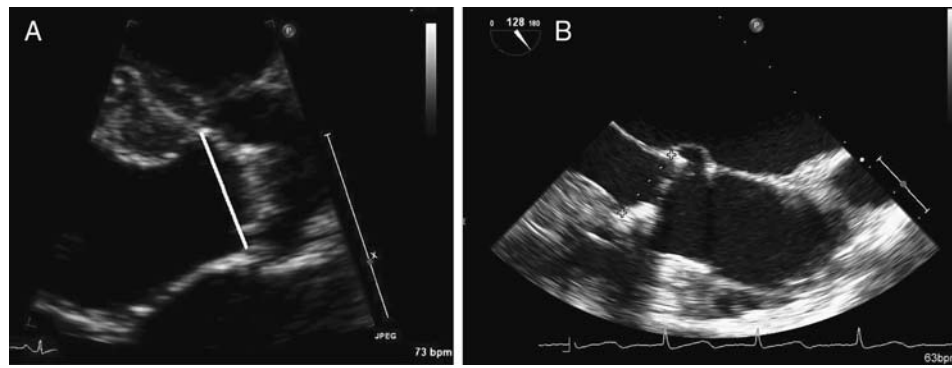

**Figure 3** Annular sizing with two-dimensional transthoracic echocardiography (A) and transoesophageal echocardiography (B). The image should be aligned to avoid oblique measurements.

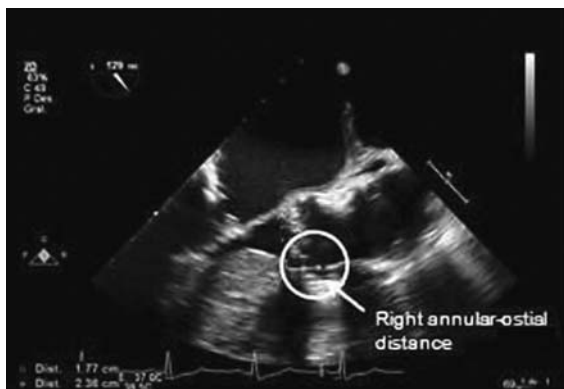

**Figure 4** The ostium of the right coronary artery can be identified using a long-axis view of the left ventricular outflow tract permitting the measurement of the annular-ostial distance and the length of the right coronary cusp.

native cusps crushed to the side. Although the determination of the right coronary annular-ostial distance should be possible with 2D TEE (Figure 4), measurement of the left coronary annular-ostial distance requires 3D TEE (see below) or MSCT.

It is also important to assess the characteristics of the ascending aorta, the aortic arch, and the descending thoracic aorta since the presence of aortic arch atheromas may increase the risk of peri-procedural embolization and therefore favour a transapical approach.

## Peri-procedural echocardiography during transcatheter aortic valve implantation

### Two-dimensional echocardiography

Although TTE clearly plays an important role in patient selection for TAVI, its role during the actual procedure is limited. In patients undergoing TAVI via a transapical approach, TTE can be helpful in locating and marking the position of the LV apex in order to guide the thoracotomy. However, there are a number of points to remember when doing this: (i) it is important to use two

orthogonal TTE apical views; (ii) the apex should be located with the surgeon and echocardiographer on the same side of the patient so that both can agree on the optimum intercostal space; and (iii) once the skin is marked with the optimal position, it is essential that the patient and/or the skin not be moved. Such movement may occur as surgical drapes are being applied and may change the position of the skin mark relative to the ribs.

The use of peri-procedural TEE is variable. The technique can aid balloon positioning during valvuloplasty, detect post-valvuloplasty aortic regurgitation, aid prosthesis positioning during implantation, confirm prosthesis function immediately post-implantation, and rapidly detect complications. However, the use of peri-procedural TEE usually requires general anaesthesia and the probe may also partially obstruct the optimal fluoroscopic view. Therefore, some operators feel that these disadvantages outweigh the many advantages of peri-procedural TEE. However, it should be noted that the transapical approach will always require general anaesthesia anyway and some centres have reported transfemoral implantation with TEE guidance using only moderate sedation. Moreover, to avoid obstructing the fluoroscopic view, the TEE probe may be retracted during the actual valve implantation and be rapidly repositioned following deployment.

Transnasal TEE is a relatively new technique<sup>28,29</sup> that can be used to monitor TAVI. Although its image quality is not quite as good as conventional TEE and transnasal TEE does not currently have 3D capability, this approach could be considered in patients where general anaesthesia is not deemed appropriate. Some sites have also adapted intracardiac echo (ICE) for TAVI, although ICE poses additional challenges in securing adequate windows.

As described more fully in a subsequent section, 3D TEE conveys certain advantages over 2D TEE during TAVI. For example, the 3D depth perspective makes it easier to visualize the position of the prosthesis on the balloon relative to the native valve annulus and surrounding structures. It also facilitates appreciation of the guide wire path through the LV and around the mitral valve subvalvular apparatus.

Both transapical and transfemoral TAVI procedures commence with balloon valvuloplasty. This is designed to split the valve commissures and make subsequent valve implantation easier. TEE can be used to guide positioning of the balloon relative to

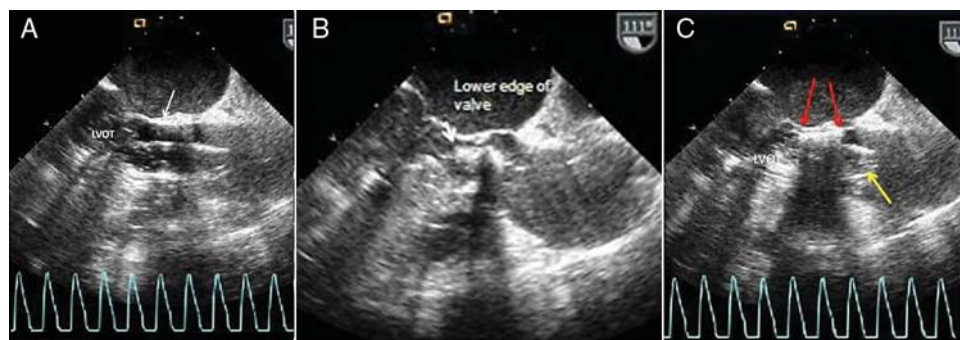

**Figure 5** (A) Two-dimensional transoesophageal echocardiography image of balloon inflation during valvuloplasty (arrow). Note electrocardiogram showing rapid right ventricular pacing. Image is aligned to show left ventricular outflow tract (LVOT), at  $\sim 120^\circ$ . (B) Two-dimensional transoesophageal echocardiography image showing lower edge of the valve crimped onto the balloon prior to deployment. Differentiating the valve from the balloon may be difficult and is facilitated with three-dimensional imaging. (C) Two-dimensional transoesophageal echocardiography image during valve deployment. Red arrows identify the ends of the stent while the yellow arrow identifies the balloon margin. Electrocardiogram displays rapid right ventricular paced rhythm.

the aortic valve and is especially useful when the valve is not very calcified and, consequently, difficult to image on fluoroscopy. It may also help in the final decision-making concerning the appropriate valve size, because a valve with bulky calcification and small sinuses may require a smaller prosthesis than the annular dimension alone would suggest.

Although balloon inflation is normally performed during rapid right ventricular pacing to reduce cardiac output, the balloon may still migrate during inflation, particularly in patients with extensive subaortic septal hypertrophy or a small sinotubular junction. Loss of right ventricular capture and premature restoration of the native rhythm may also result in balloon migration. TEE may be used to confirm a stable position during inflation and to monitor the behaviour of the calcified aortic cusps during inflation as they are pushed back into the sinuses and towards the coronary ostia (Figure 5A)

During deployment of the prosthesis, TEE is very helpful in confirming the correct position of the valve and is usually used in conjunction with fluoroscopy for this purpose. In patients with limited native valve calcification or for valve-in-valve procedures where TAVI is used in the setting of another bioprosthesis, TEE may be the main technique used for guidance.

The optimal position for the Edwards SAPIENT<sup>TM</sup> valve is with the ventricular side of the prosthesis positioned 2–4 mm below the annulus in the LVOT. Examples of 2D TEE imaging during prosthesis positioning and deployment are shown in Figure 5B and C. Since the CoreValve<sup>TM</sup> has a different structure, the ventricular edge of the prosthesis should be placed 5–10 mm below the aortic valve annular plane. A normally positioned CoreValve<sup>TM</sup> is shown in Figure 6.

Immediately following deployment, TEE is used to confirm satisfactory positioning and function of the prosthesis (Figure 7A and B). This requires a combination of 2D imaging and Doppler evaluation with 3D also used if available. When the prosthesis is positioned too low, it may impinge on the mitral valve apparatus (Figure 8) or it may be difficult to stabilize in patients with marked subaortic septal hypertrophy. The native valve cusps may also fold over the

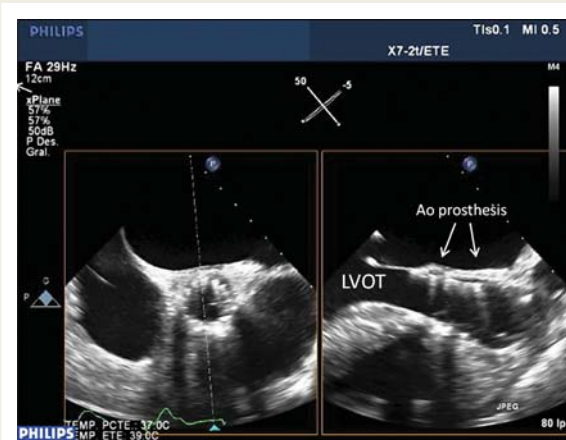

**Figure 6** Short- and long-axis views (derived using a three-dimensional transoesophageal echocardiography probe) of a normally deployed CoreValve<sup>TM</sup>. LVOT, left ventricular outflow tract.

top of the prosthesis and impede its function. If the prosthesis is implanted too high, it may migrate up the aorta, obstruct the coronary ostia, or be associated with significant PVR.

It is important to confirm that all the prosthetic cusps are moving well, that the valve stent has assumed a circular configuration (using 2D or 3D views), and that there is no significant valvular or PVR. Some regurgitation through the prosthesis will be common, whereas the delivery apparatus and/or guide wire remain across the valve and may persist, to a lesser degree, after their removal as it may take a few minutes post-implant for the leaflets to completely recover from being crimped for deployment. Until this occurs, the cusps may not coapt completely and mild valvular regurgitation may be transiently observed. Transgastric TEE views with continuous-wave, pulsed-wave, and colour Doppler should be used to confirm satisfactory prosthetic

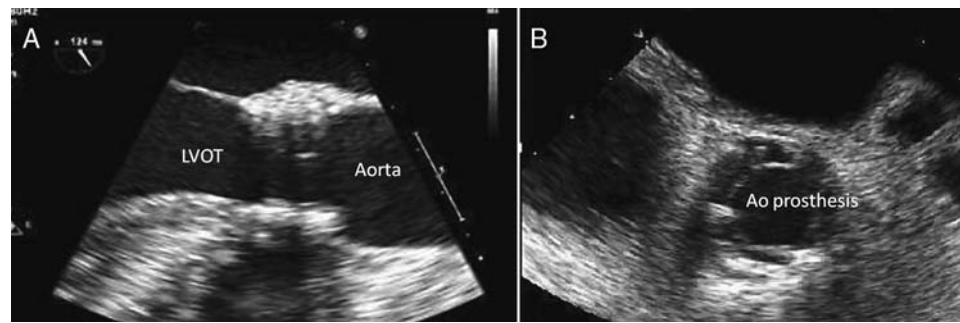

**Figure 7** Two-dimensional transoesophageal echocardiography images showing an optimally implanted SAPIENT™ valve in (A) a diastolic long-axis view and (B) a systolic short-axis view, LVOT, left ventricular outflow tract.

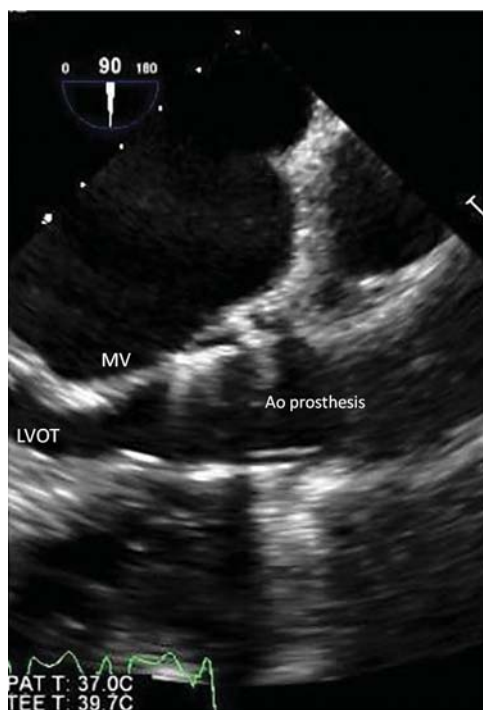

**Figure 8** Two-dimensional transoesophageal echocardiography long-axis view of a SAPIENT™ valve that has been implanted too low. Note the position of the strut adjacent to the anterior mitral leaflet. LVOT, left ventricular outflow tract; MV, mitral valve.

functioning before the probe is finally removed. This window is essential to ensure that all regurgitant jets are detected (Figure 9).

PVR, not infrequently with multiple jets, is common following TAVI, though trace to mild and with a benign stable course in the majority of patients.<sup>30</sup> On the other hand, severe aortic regurgitation may occur as a consequence of incomplete expansion or incorrect positioning of the device, restricted cusp motion, or inappropriate prosthetic size.<sup>31</sup> An undersized prosthesis is expected to be associated with paravalvular aortic regurgitation. In contrast, an oversized prosthesis may result in suboptimal stent expansion,

impaired cusp mobility, and central aortic regurgitation. Moreover, in the presence of severe asymmetric calcification of the native aortic valve, deficient (asymmetric) accommodation of the stent may occur, causing PVR of varying severity. The approach to assessing post-TAVI aortic regurgitation is discussed in detail in a later section. However, in the context of the immediate post-implantation assessment, conventional criteria including using colour jet dimensions, vena contracta, pressure half-time, and quantitative Doppler may all be helpful.<sup>32,33</sup> Three-dimensional TEE is an additional tool to evaluate the early function of the bio-prosthesis and define the severity and precise location of paravalvular and/or central regurgitation.<sup>34</sup> Additionally, the patient's haemodynamic status and aortography may all help identify the patient with excessive regurgitation.

In the case of moderate paravalvular aortic regurgitation, supplementary balloon dilation can be performed. However, the risk of aortic rupture, cusp trauma, and over dilatation of the stent, all of which might worsen central aortic insufficiency, must be considered. Aortic regurgitation has also been reported as a consequence of residual native aortic valve leaflet tissue prolapsing into the prosthesis, interfering with cusp motion and coaptation. This may result from deficient containment of residual native aortic tissue by the prosthesis<sup>35</sup> and/or positioning the valve too low.

The extreme consequence of prosthesis mismatch (or failed pacing capture) is prosthetic embolism. If the embolization occurs towards the aorta, it might be resolved through successful transcatheter repositioning, but if it happens towards the LV, surgical removal is usually the only option.<sup>36,37</sup>

During the procedure, the echocardiographer may be alerted to acute, severe hypotension. Possible explanations identifiable by TEE are cardiac tamponade secondary to wire perforation of the left or right ventricle, LV dysfunction, or severe aortic regurgitation. Left ventricular dysfunction with acute wall motion abnormalities may be secondary to ostial occlusion by fragment embolization or by an obstructive portion of the valve frame, sealing cuff, or native cusp.<sup>8</sup> Although this complication may be fatal, successful management of ostial occlusions with percutaneous angioplasty or bypass surgery has been reported.<sup>38</sup>

Another possible complication of TAVI is sudden worsening of MR. This may occur due to right ventricular pacing (LV asynchrony) or as a consequence of prosthetic misplacement with



pressure exerted on the anterior mitral leaflet from the ventricular edge of the prosthesis (Figures 10 and 11) or by direct damage or distortion of the subvalvular apparatus. The latter is more common with the antegrade apical approach, as the catheter might trap the subvalvular apparatus when passing through the LV towards the outflow tract. This may cause temporary or, in the case of chordal or leaflet rupture, permanent distortion and severe MR. Careful echocardiographic monitoring of the mitral valve during and after implantation can help avoid this complication.<sup>39,40</sup>

Rarely, (frequency 0–4%),<sup>39,40</sup> a tear or rupture of the aortic root may be observed during the procedure after balloon

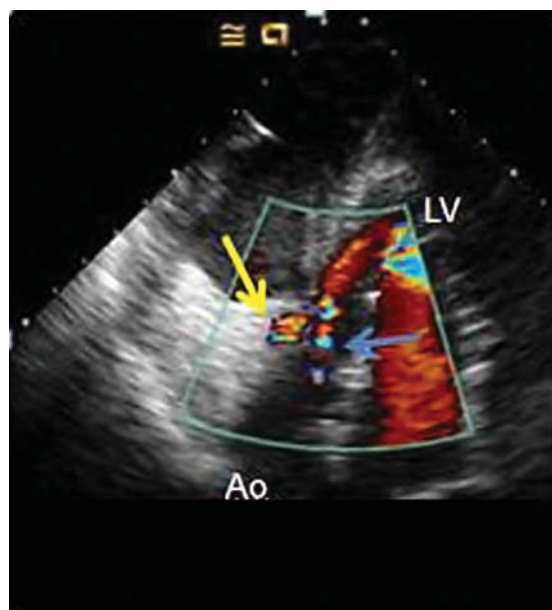

**Figure 9** Deep transgastric transoesophageal echocardiography view of a newly implanted SAPIEN™ valve showing both paravalvular (yellow arrow) and valvular (blue arrow) regurgitation. Ao, aorta; LV, left ventricle.

valvuloplasty or prosthesis deployment, especially in the presence of extensive annular calcification or prosthesis oversizing.<sup>41</sup> Inspection of the ascending aorta and aortic arch may also detect aortic cusp fragment embolization or atheroembolism. These complications, along with thrombo-embolism from catheters, air embolism, prolonged hypotension, or arch vessel dissection, may cause stroke which occurs with rates ranging from 0 to 10%.<sup>40</sup>

Most of the peri-procedural complications just described may arise with either the SAPIEN™ valve or CoreValve™ (Table 1). However, because the CoreValve™ extends into the LV with close proximity of the skirt of the valve to the membranous septum where the atrioventricular (AV) node is located, conduction abnormalities are more common with the CoreValve™ than with the SAPIEN™ valve.<sup>42</sup> Optimal deployment of the valve can decrease the risk of this complication. Additionally, the CoreValve™ can be repositioned during deployment and its format and larger length make stable positioning more independent of valvular calcification than the SAPIEN™ valve.

### Three-dimensional echocardiography

A complete understanding of the 3D anatomy of the aortic and mitral valves by interventionalists and imagers has become the foundation for accurate placement of new transcatheter devices. Although 3D TTE imaging is undergoing dramatic improvements and the development of real-time 3D colour Doppler imaging will simplify quantification of valvular regurgitation, the current TTE technology plays a limited role in TAVI. Therefore, this section will focus on the utility of 3D TEE in TAVI.

Although 3D TEE may be helpful in distinguishing between tricuspid and bicuspid valves,<sup>43</sup> this is rarely an indication for 3D TEE. However, defining the aortic valve annulus is a particularly important aspect of pre-implantation TEE and an area where 3D can be extremely helpful. Piazza *et al.*<sup>24</sup> has described the AV complex as being composed of four rings: the virtual annulus, the anatomic annulus, the sinotubular junction, and a crown-like ring from the cusps. The anatomic annulus is located where the muscular arterial aortic root joins the myocardium of the septum anteriorly and the fibrous tissue of the mitral valve posteriorly. Two-thirds of the ring abuts the septum and one-third of the

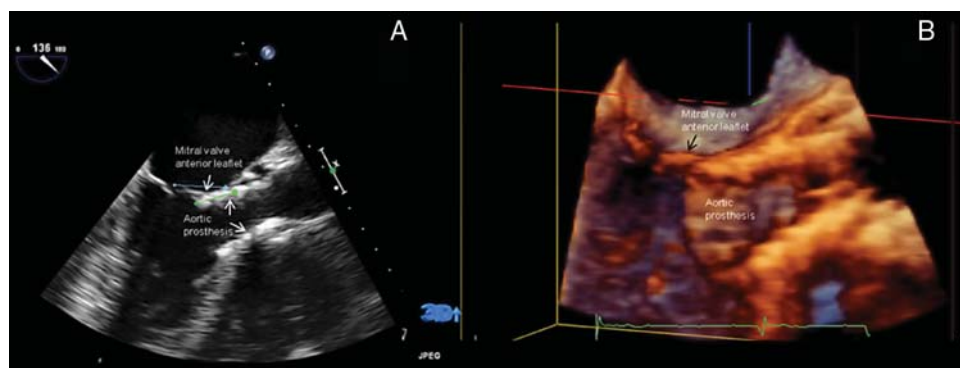

**Figure 10** Two-dimensional (A) and three-dimensional transoesophageal echocardiography (B) images of a CoreValve™ which has been implanted low, distorting the anterior mitral leaflet and causing mitral regurgitation (data not shown).

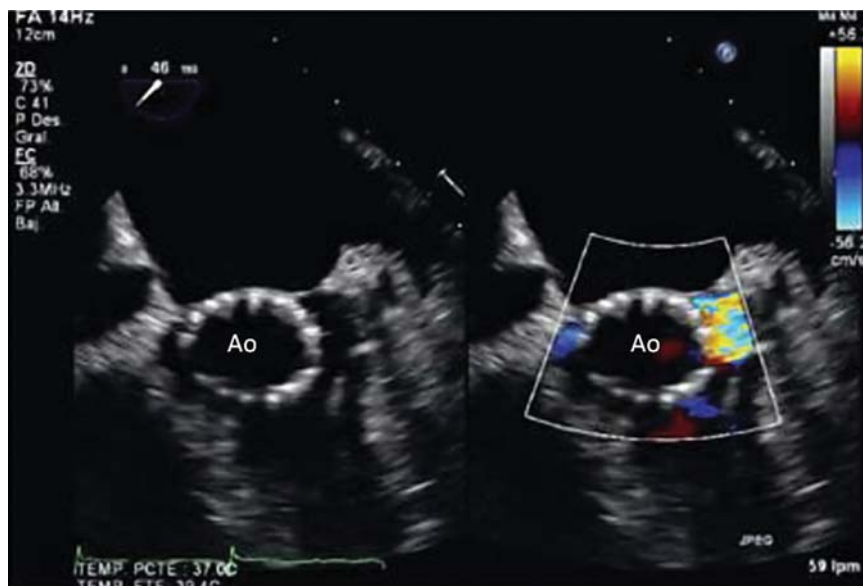
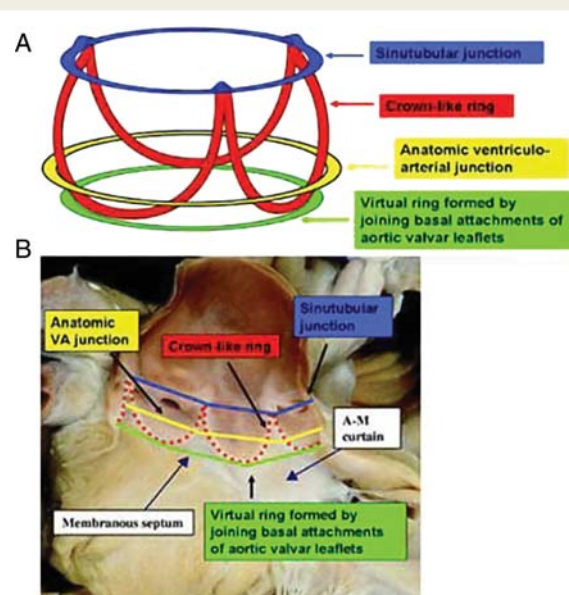

**Figure 11** Two-dimensional transoesophageal echocardiography image of a CoreValve™ associated with paravalvular regurgitation. Ao, lumen of the aortic prosthesis. Reprinted with permission from Gonçalves et al.<sup>34</sup>

**Table 1** Peri-procedural complications of transcatheter aortic valve implantation assessable by echocardiography

Aortic prosthesis misplacement
Embolization towards the aorta or left ventricle
Deployed valve is positioned too high (towards the aorta) or too low (towards the mitral valve apparatus)
Aortic regurgitation
Central
Paravalvular
Mitral regurgitation
Aortic prosthesis impinges on the anterior mitral leaflet
Left ventricle asynchrony caused by right ventricular pacing
Damage or distortion of the subvalvular mitral apparatus by delivery system
New left ventricular wall motion abnormalities
Acute coronary ostial occlusion
Cardiac tamponade
Perforation of the left or right ventricle
Dissection or rupture of the aortic root

ring the anterior mitral valve (Figure 12). What we measure as the AV annulus is the virtual ring which is also the hinge point of the AV cusps. Because the AV typically has three equal cusps, bisecting the aortic annulus to measure the maximum diameter will typically result in an image where the immobile, calcified right coronary cusp is anterior and the commissure between the left and non-coronary cusps is posterior. As shown in Figure 13, the orientation of the typical 2D parasternal long-axis view that



**Figure 12** Schematic showing three-dimensional structure of a native aortic valve. Reprinted with permission from Piazza et al.<sup>24</sup>

displays the commissure between right and non-coronary cusps (red arrow) does not show the maximum diameter of the annulus (blue arrow). Three-dimensional TEE can be very useful in accurately sizing the annulus because aligning the short-axis view of the AV to present the true annulus allows the assessment of its circularity and the measurement of the maximum diameters (Figure 14).

Although 2D TEE is able to define the annular-ostial distance for the right coronary, measurement of the distance from the annulus to the left main coronary ostium requires 3D TEE as the left main coronary artery ostium lies in the coronal plane which cannot be acquired by standard 2D imaging. However, using 3D full-volume acquisition of the aortic valve and multiplanar reconstruction allows a rapid intra-procedural derivation of the coronal plane for measurement of the annulus-to-left main distance and for imaging the left coronary cusp length (Figure 15). In general, a distance of >10 mm is desirable for the 23 mm balloon-expandable valve and a distance of >11 mm is desirable for the 26 mm valve. This measurement is not necessary for the self-expanding prosthetic aortic valve.

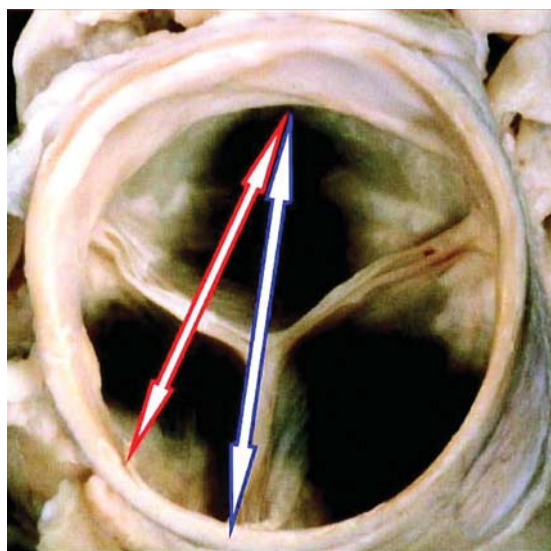

**Figure 13** Anatomic short axis of the aortic valve illustrating the disparity between annular diameter as measured by the two-dimensional parasternal long-axis view (red arrow) vs. the true anatomic transverse diameter (blue arrow). Reprinted with permission from Piazza *et al.*<sup>24</sup>

Live 3D (narrow sector) may also be useful when positioning the transcatheter valve across the annulus. Although the 2D TEE long-axis ( $\sim 120^\circ$ ) view may be adequate for positioning, severe calcification of the AV and annulus, as well as dystrophic calcification of the anterior mitral leaflet, may cause significant acoustic shadowing of the transcatheter valve and make it difficult to distinguish the valve from the balloon. Live 3D imaging, however, increases the 'field of view' and frequently improves localization of the crimped valve margins within the aortic valve apparatus (Figure 16). The biplane view that provides complementary 2D planes is also very helpful in monitoring valve positioning and deployment (Figure 17).

Three-dimensional TEE is probably most useful immediately following valve deployment when the echocardiographer must rapidly and accurately assess the position and function of the valve including identifying the presence/severity of aortic regurgitation (Figures 18 and 19). Significant regurgitation may be an indication for repeat balloon inflation to attempt maximal expansion of the valve. Biplane colour Doppler imaging allows a rapid, accurate assessment of PVR from simultaneous long- and short-axis views. Finally, 3D colour Doppler volume sets obtained from deep gastric and/or mid-oesophageal views may allow direct planimetry of the regurgitant orifice(s).

### Post-implantation follow-up

The echocardiographic follow-up evaluation of transcatheter valves is, in most ways, the same as that for surgically implanted prostheses as guided by previously published guidelines for prosthetic valves.<sup>33</sup> However, two areas provide challenges that are somewhat unique to transcatheter valves.

First is the calculation of effective orifice area or other indices of valve opening that are founded in the ratio of post- to pre-valvular velocities. Since there is flow acceleration within the transcatheter stents proximal to the valve cusps and then additional flow acceleration at the level of the cusps, it is essential that the pre-valvular velocity be recorded proximal to the stent and the post-valvular velocity (typically recorded with continuous-wave Doppler) reflect that distal to the stented valve. If the LVOT velocity used in calculations is erroneously recorded within the stent but

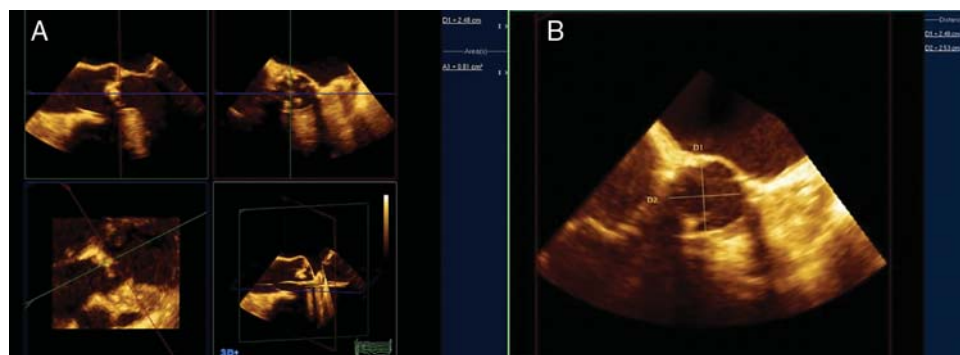

**Figure 14** Three-dimensional transoesophageal echocardiography provide an accurate assessment of the shape and maximum diameters of the aortic annulus. Note (A) that the red plane is positioned so that it provides an optimized on-axis view of the annulus (B).



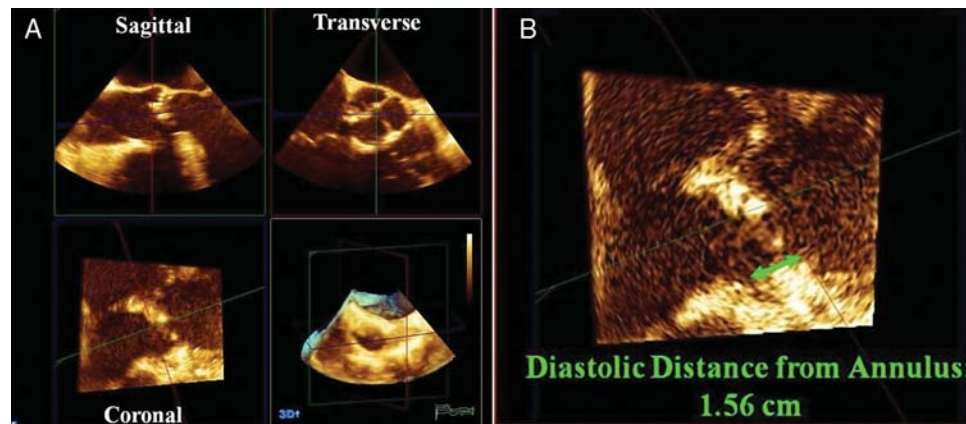

**Figure 15** Three-dimensional full-volume sets can be used to image the aortic valve in the coronal plane and measure the left annular-ostial distance. (A) Sagittal, transverse, and coronal planes are imaged using multiplanar reconstruction. (B) The annulus-to-left main ostium length is measured (green arrow).



**Figure 16** Live three-dimensional image illustrating the utility of this technique in defining the margins of the valve stent (red arrow). This mode allows slight 'angulation' of the 130° view of the delivery system as it sits in the aortic root and enhances the demarcation between the valve stent and the delivery balloon. In this image, the upper margin sits at the level of the sinotubular junction.

proximal to the cusps, the result will be an overestimation of valve area.<sup>44</sup>

A second area of difficulty arises with the accurate quantification of aortic regurgitation which may consist of central and PVR, the latter not infrequently including multiple small jets. Accurate assessment of the severity of post-TAVI aortic regurgitation is difficult in the absence of validated methods to quantify PVR. Qualitative methods for assessing native valvular regurgitation have been well described<sup>45</sup> and can be applied to the assessment of prosthetic valve regurgitation.<sup>33</sup> Colour-flow Doppler is most commonly used to assess the regurgitant jet size. The length of the jet is an unreliable indicator of severity and the proximal jet width or cross-sectional area of the jet beneath the prosthesis (within the LVOT) is preferred for central jets. Although colour-flow Doppler

assessment typically relies on visual estimates of severity, the guidelines suggest using the following criteria for jet width based on the %LVOT diameter occupied:  $\leq 25\%$  suggests mild, 26–64% suggests moderate, and  $>65\%$  suggests severe. These methods are limited in the setting of paravalvular jets which are frequently eccentric and irregular in shape.

The size of the jet vena contracta is an estimate of the effective regurgitant orifice area (EROA) and, as such, is a more robust estimate of regurgitant severity. Unfortunately, in the setting of prostheses, portions of the sewing ring may not be imaged due to acoustic shadowing. In addition, there has been no validation for adding the vena contracta widths of multiple jets as may be encountered post-TAVI. The ASE/EAE guidelines<sup>33</sup> suggest that for paravalvular jets, the proportion of the circumference of the sewing ring occupied by the jet gives a semi-quantitative guide to severity:  $<10\%$  of the sewing ring suggests mild, 10–20% suggests moderate, and  $>20\%$  suggests severe. However, this assumes continuity of the jet which may not be the case for transcatheter valves and therefore may overestimate the severity when there are multiple small jets. This approach also does not consider that the radial extent of paravalvular jets may vary and in the case of transcatheter valves may be very small. Attempting to add the degrees of involvement when jets are small is equally challenging.

Quantitative methods for calculating regurgitant volume and EROA rely on the comparison of stroke volumes across the aortic valve (representing total stroke volume) and a non-regurgitant valve (either mitral or pulmonary) and can be used for prosthetic valves.<sup>33</sup> Although total stroke volume (regurgitant and forward volumes) can be measured by subtracting LV end-systolic volume from end-diastolic volume, the more common method is to calculate the stroke volume across the LVOT. Three-dimensional echocardiography may become the method of choice for assessing aortic regurgitant volume and EROA. Validation of this technology for quantitating native aortic regurgitation is growing,<sup>46</sup> although the utility of 3D echocardiography for the assessment of prosthetic regurgitation has yet to be determined.



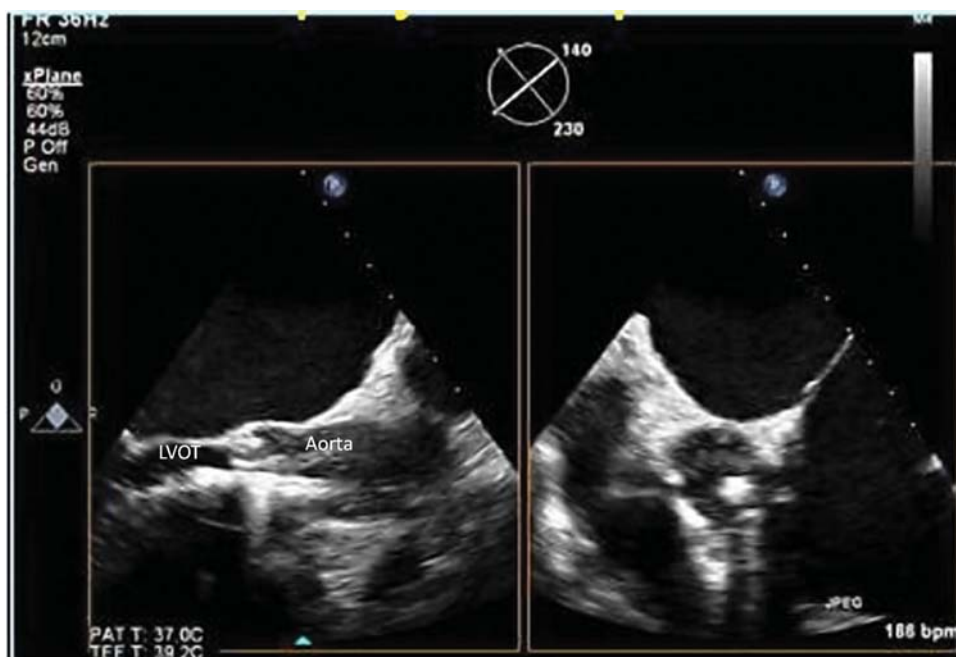

**Figure 17** Simultaneous biplane images made possible with three-dimensional transoesophageal echocardiography probes show valve positioning across the native valve in long and short axis. LVOT, left ventricular outflow tract.



**Figure 18** Normal three-dimensional transoesophageal echocardiography diastolic short-axis image of a SAPIEN™ valve.



**Figure 19** Three-dimensional diastolic colour Doppler image revealing valvular aortic regurgitation following SAPIEN™ valve implantation. LVOT, left ventricular outflow tract.

Secondary signs supporting the diagnosis of significant prosthetic regurgitation include excessive rocking of the prosthesis (associated with >40% dehiscence), a short pressure half-time of the continuous-wave Doppler signal of aortic regurgitation, a dense spectral display, or diastolic flow reversal in the descending aorta (pulsed-wave Doppler from the suprasternal notch) and/or abdominal aorta (subcostal view). Sometimes, however, it remains impossible to be confident about whether aortic prosthetic regurgitation is moderate or severe and a comprehensive integrated approach must always be used.

### Future directions

Despite the success and rapid technical advances of transcatheter AVR procedures,<sup>47,48</sup> limitations remain. In addition to the SAPIEN™ and CoreValve™ valves that are currently available, other new valve and deployment systems are in development.<sup>49</sup> The future holds much promise, requiring alternatives for patients with difficult vascular access, expansion of target patient

populations, more accurate prosthesis deployment, and establishment of long-term prosthetic durability.

The future of TAVI will also include imaging improvements. Currently, it is challenging to place echocardiographers and echocardiography machines in a position that allows free movement of fluoroscopy cameras, ensures patient access by interventionalists, surgeons, and anaesthesiologists, and minimizes radiation exposure to the echocardiographers. Integrated, small imaging consoles would be helpful as would be improved intracardiac ultrasound devices, ideally with 3D capability, that might ultimately reduce the need for TEE.

## Percutaneous transcatheter repair of paravalvular regurgitation

### Introduction

PVR after surgical valve replacement is typically associated with dehiscence of sutures and may result from infection, annular calcification, friable/weak tissue at the site of suturing, or technical factors at the time of implantation. Most commonly encountered with mitral prostheses, paravalvular leaks may be associated with haemodynamically significant regurgitation causing heart failure and/or haemolysis. Because reoperation for PVR is associated with an increased likelihood of a recurrent leak as well as surgical morbidity and mortality, transcatheter closure is appealing.

Transcatheter closure of paravalvular leaks was first reported in 2003 using a ductal coil.<sup>50</sup> Since then, various devices, including the Rashkind umbrella, the CardioSeal device, Amplatzer septal occluder, and Amplatzer duct occluder, have been used with varying degrees of success.<sup>51</sup> More recently, devices specifically designed for the treatment of PVR have been developed.<sup>52</sup> Although there has been growth in these procedures, successful closure is limited by the anatomy of the defects which tend to be irregular and may be multiple, technical challenges in positioning closure devices and the limitations of available devices and imaging modalities. Finally, even small haemodynamically insignificant residual defects may cause clinically significant haemolysis so that device closure may be a haemodynamic success but an overall medical failure. Despite the associated technical challenges, the use of multiple smaller devices may be preferable to a single large device and the concept of implantation of a device at the time of surgical implantation (for example when exuberant annular calcification limits suturing) has been introduced.

Echocardiography has proven essential in paravalvular leak closure with both TEE and intracardiac echocardiography (ICE)<sup>53</sup> used to guide these procedures. Three-dimensional TEE<sup>54–56</sup> is now considered the preferred TEE imaging modality as it is uniquely capable of demonstrating the irregular (frequently crescentic) shape of the defects and is better able to identify multiple defects and provide accurate sizing.

### Echocardiographic evaluation of paravalvular regurgitation

The approach to assessing prosthetic PVR is similar to that used for native valve regurgitation but is technically more demanding

and limited by artefacts from the highly reflective components of the prosthetic valve that can mask part or all of a regurgitant jet. This is particularly problematic when TTE is used to evaluate mechanical mitral prostheses. With TEE, the left atrium becomes the near-field chamber and MR can be more readily assessed. Patients with aortic prosthetic valves can usually be adequately assessed by TTE because the aortic prosthesis does not obscure aortic regurgitation to the same extent. However, even in this setting, TEE should be considered because it provides high-quality images and allows for a more precise determination of the location and severity of PVR.<sup>33,57,58</sup>

In assessing PVR in mitral prostheses, the actual area of dehiscence can be detected by TEE as an area of echo drop-out outside the sewing ring (*Figure 20A*). This must be confirmed by the presence of the paravalvular regurgitant jet on colour-flow imaging.<sup>33</sup> In order to facilitate communication between the echocardiographer and the interventionalist, the location of the dehiscence is best described in relation to internal landmarks such as the left atrial appendage, aortic valve, and crux of the heart (*Figure 21*).

Colour-flow imaging is used to localize the paravalvular regurgitant jet as well as to assess the severity. Commonly used parameters of MR severity in this setting are jet width and jet area. Although the proximal isovelocity surface area (PISA) approach has not been validated in the setting of PVR, the presence of a large PISA shell is consistent with more severe regurgitation. The quantitative Doppler method is not suitable for assessing PVR since the prosthesis confounds the measurement of antegrade transvalvular flow. Pulsed Doppler assessment of the pulmonary vein pattern can be useful, and the detection of systolic retrograde flow is a specific sign of severe MR.<sup>33</sup>

The entire sewing ring should be examined by meticulously sweeping the mitral prosthesis from 0° to 180°, quantitating the circumferential extent of dehiscence by noting the angle at which the jet(s) is(are) first detected to the point of disappearance. Multiple regurgitant jets can be identified by the presence of intervening areas where the attachment of the sewing ring is intact. Although not obtainable in all cases, the transgastric view with colour-flow imaging showing the valve ring in short axis should always be attempted because it provides an *en face* view of the entire circumference of the valve ring.

Real-time 3D TEE imaging is a major advance in the localization and quantification of paravalvular MR, because it can consistently provide an *en face* view of the mitral prosthesis allowing the accurate determination of the number and location(s) of areas of paravalvular dehiscence (*Figure 22A*). The location and orientation of the paravalvular regurgitant jets can be further delineated using 3D colour-flow imaging (*Figure 23*).<sup>57,59</sup> Although 3D TEE may permit the planimetry of the regurgitant orifice(s), the resolution may be limited when the areas of dehiscence (and associated regurgitant orifices) are slit-like.

Assessment of aortic prosthetic PVR with 2D TEE is less consistently successful. The aortic prosthesis may not be imaged adequately due to distortion of the aortic valve plane that may occur in patients with aortic valve disease and a proper short-axis *en face* view of the aortic prosthesis may be difficult to obtain, particularly for mechanical valves. The anterior aspect of the valve ring, which is located in the far field, is frequently obscured by

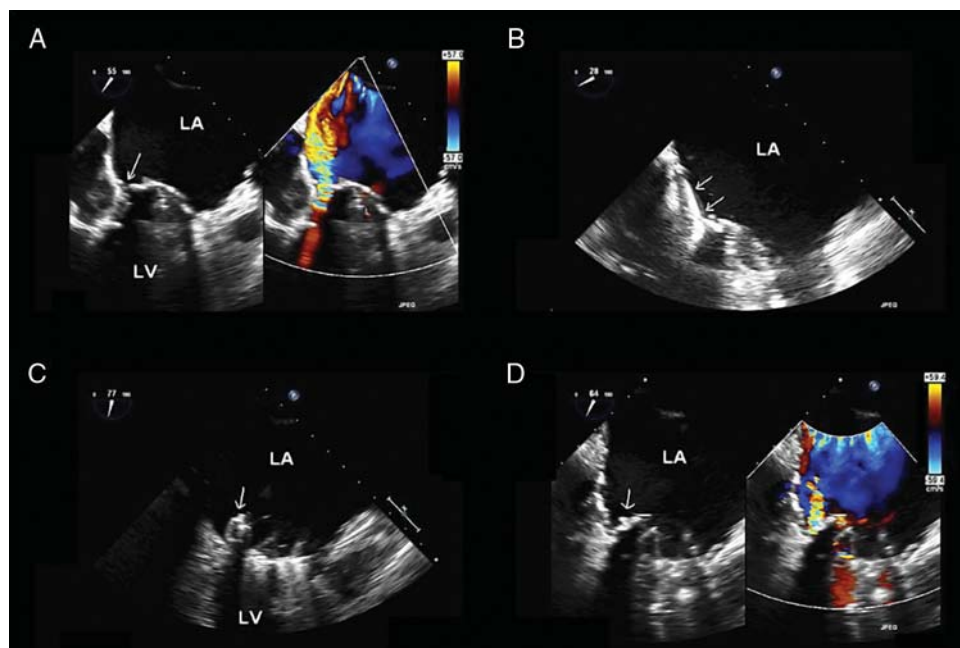

**Figure 20** Two-dimensional transoesophageal views in a patient with a mechanical mitral bileaflet prosthetic valve and paravalvular regurgitation. (A) The area of dehiscence is visualized as a defect (arrow) at the posterior aspect of the valve ring with demonstration of paravalvular regurgitation by colour-flow imaging. (B) The guide wire (arrows) has been passed through the defect. (C) The closure device (arrow) is open. (D) The closure device is positioned securely in the defect and colour-flow imaging shows only mild residual paravalvular regurgitation. LA, left atrium; LV, left ventricle.

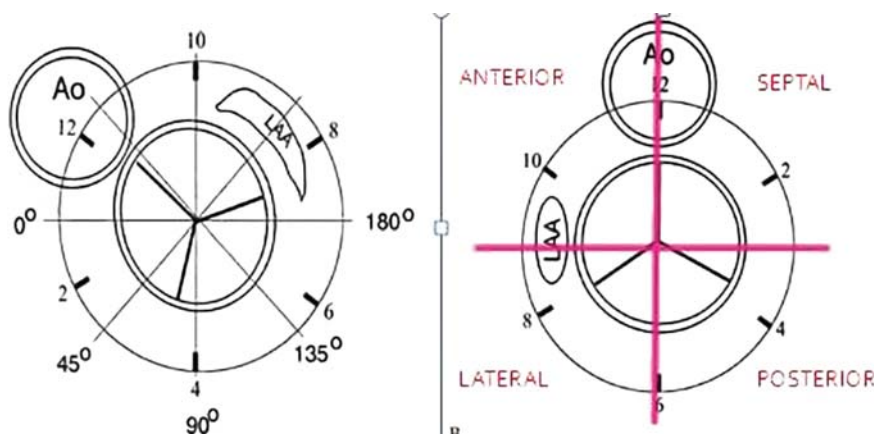
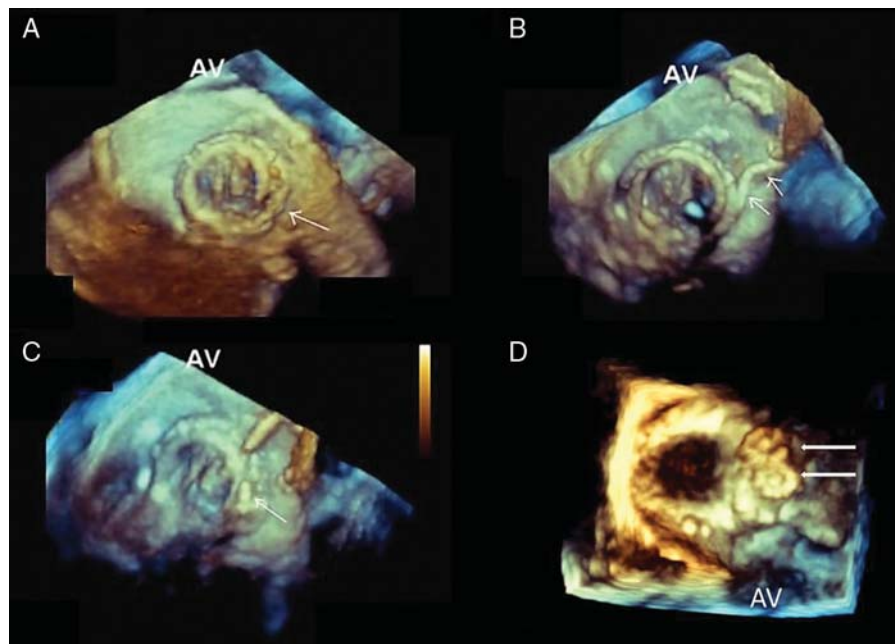

**Figure 21** Schematic diagram for use in describing the location and extent of sites of paravalvular regurgitation using as main references the aorta (Ao) and the left atrial appendage (LAA). On the left is the echocardiographic view and on the right the anatomic view. Reprinted with permission from Luigi M.<sup>80</sup>

reverberation artefact/acoustic shadowing from the posterior valve ring, such that anteriorly located PVR may be difficult to identify. These technical difficulties also limit 3D TEE imaging, which is not as helpful as in the setting of mitral prostheses. In addition to mid-oesophageal long- and short-axis views (Figure 24A and B), the transgastric view should be routinely attempted and a good display of the LVOT can be obtained by using a longitudinal imaging plane at about 100–120° with leftward flexion of the

transducer (Figure 24C). A zero-degree deep transgastric view with antelexion and leftward angulation may also be helpful (Figure 24D). Paravalvular aortic regurgitation can usually be appreciated using these views, although the spatial resolution of images from this window may be inadequate to provide accurate localization of the paravalvular jet(s).

In assessing aortic prosthetic valves, the location of the coronary arteries should be routinely assessed. A coronary ostium low in



**Figure 22** Transoesophageal three-dimensional view of a mechanical mitral bileaflet prosthetic valve from the atrial perspective. (A) The dehiscence (arrow) at the posterior aspect of the valve ring is seen. (B) The guide wire (arrows) has been passed through the dehiscence. (C) Following placement of the first occluder (arrow), a guide wire has been positioned to permit placement of a second occlude for residual regurgitation (not shown). (D) At the conclusion of the procedure, two adjacent occluders are present (double arrows). AV, aortic valve.

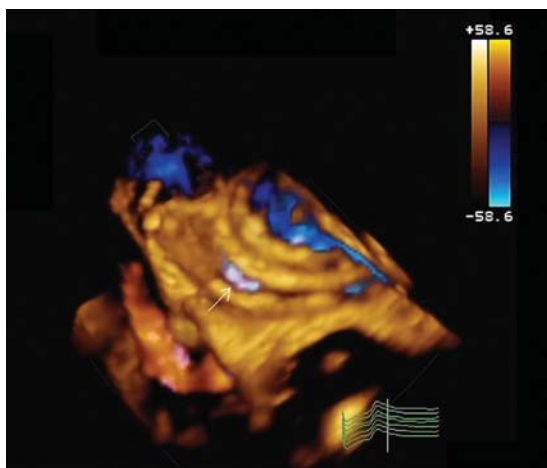

**Figure 23** Transoesophageal three-dimensional colour-flow imaging shows the origin of the paravalvular mitral regurgitant jet (arrow) at end systole.

the aortic sinus close to the valve ring may pose a significant technical problem in transcatheter paravalvular leak closure and affect the choice of closure device.<sup>59,60</sup> The left main ostium can usually be imaged with the transverse plane at the aortic sinus level with the aortic root in the short axis, although, as previously noted, measuring the annular-ostial distance requires 3D imaging. The proximal 1–2 cm of the right coronary artery can usually be

visualized by slowly sweeping the aortic sinus from the annulus to the sinotubular junction using the transverse plane at 0–45° or in the long-axis view of the aortic root (120°) where it is seen to leave the aorta at ~6 o'clock. The locations of the coronary ostia and orientation of the aortic sinuses (right coronary, left coronary, and non-coronary) serve as useful internal landmarks when communicating the location of the paravalvular jet(s) to the interventionalist. In addition to the jet width and jet area, a flow convergence area in the aortic root should be carefully sought. The presence of a clearly defined flow convergence not only pinpoints the location of dehiscence but also indicates that the regurgitation is significant.<sup>33</sup>

### Peri-procedural echocardiography during transcatheter repair of paravalvular regurgitation

Although there is some experience in performing aortic paravalvular leak closure with ICE, TEE is considered to be an integral part of transcatheter closure of PVR<sup>57,58,61–63</sup> and has a role in the selection of appropriate patients, facilitation of the procedure, and assessment of the results (Table 2). Since most patients should already have had a comprehensive TEE before being accepted for the procedure, usually only a brief goal-oriented pre-procedure TEE is performed to confirm the location(s) and severity of PVR. A real-time 3D image using the zoom option can be acquired to provide the interventionalist with a display of the paravalvular defect, particularly in the mitral position.<sup>57,59</sup> However, care must be taken to avoid misdiagnosing areas of echo



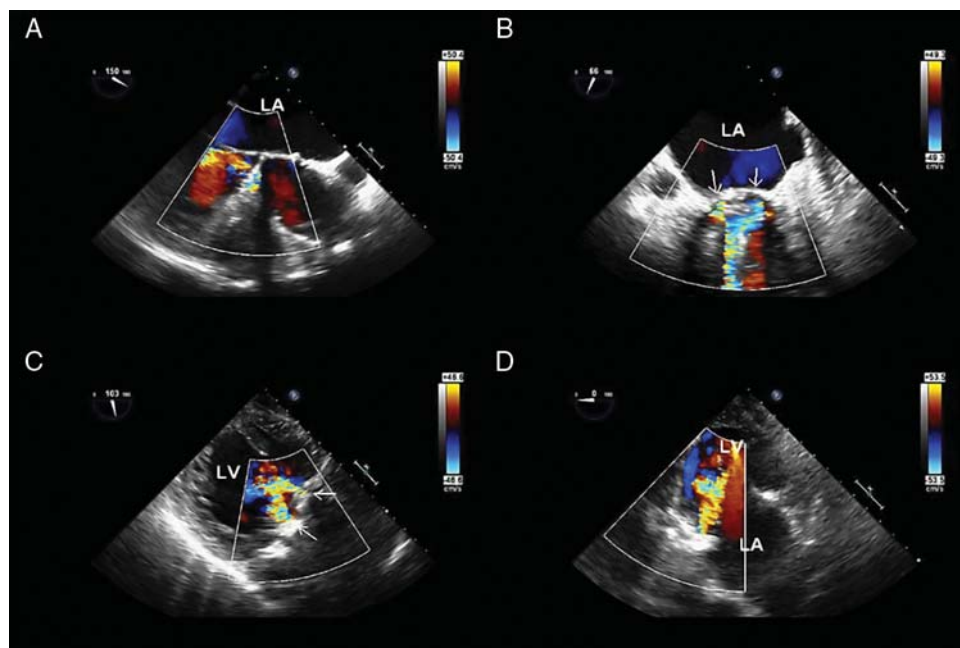
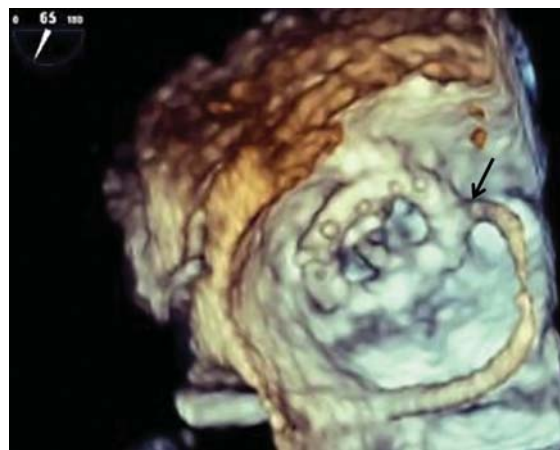

**Figure 24** Transoesophageal mid-oesophageal long- (A) and short-axis (B) views of an aortic mechanical bileaflet valve show two paravalvular aortic regurgitant jets (arrows), best seen in the short-axis view. The transgastric view with leftward flexion confirms the presence of the two jets (arrows) (C), but the deep transgastric view shows only one jet (D). LA, left atrium; LV, left ventricle.

**Table 2** Role of peri-procedural transoesophageal echocardiography in device closure for paravalvular regurgitation

Confirm location(s) and severity of paravalvular regurgitation
Exclude prosthetic and intracardiac thrombi or vegetations
Facilitate guide wire and catheter placement
Assess seating of the closure device
Ensure proper functioning of the prosthetic valve
Assess residual paravalvular regurgitation
Detect complications such as air embolism or tamponade

drop-out as paravalvular defects and confirmation with colour mapping should be performed. In addition, volume sets are needed to measure the areas of dehiscence for device sizing and to display the associated regurgitant jet(s). If the dehiscence is large (exceeding 25% of the circumference), a single device is unlikely to be sufficient. Additionally, when the defect is larger than 25% of the circumference, the prosthesis may rock and it may be inadvisable to proceed with device closure because of the high risk of device embolization.<sup>58,60</sup> With small defects where closure may be contemplated to correct haemolysis, smaller and less bulky devices such as coils can be used for closure.<sup>57,58</sup> Since anticoagulation may have been withheld in these patients, thrombus formation on the prosthetic valve or within the cardiac chambers should be excluded. The presence of intracardiac thrombus increases the risk of thrombo-embolic events during the procedure and mandates that the procedure be postponed.



**Figure 25** Real-time three-dimensional image from a left atrial perspective showing the path of the guide wire (arrow) as it passes through the interatrial septum (left), across the left atrium and through the paravalvular defect.

When the antegrade approach is used, TEE may be used to guide the transseptal puncture and help minimize the risk of inadvertent puncture of the aorta or atrial wall. TEE also can help guide the passage of the guide wire and catheter through the defect (Figure 20B). Real-time 3D TEE has been shown to be particularly helpful in this regard (Figure 22B and Figure 25). Injection of contrast has also been used to identify the position of the tip of the catheter in relation to the defect.<sup>58</sup> During deployment of the

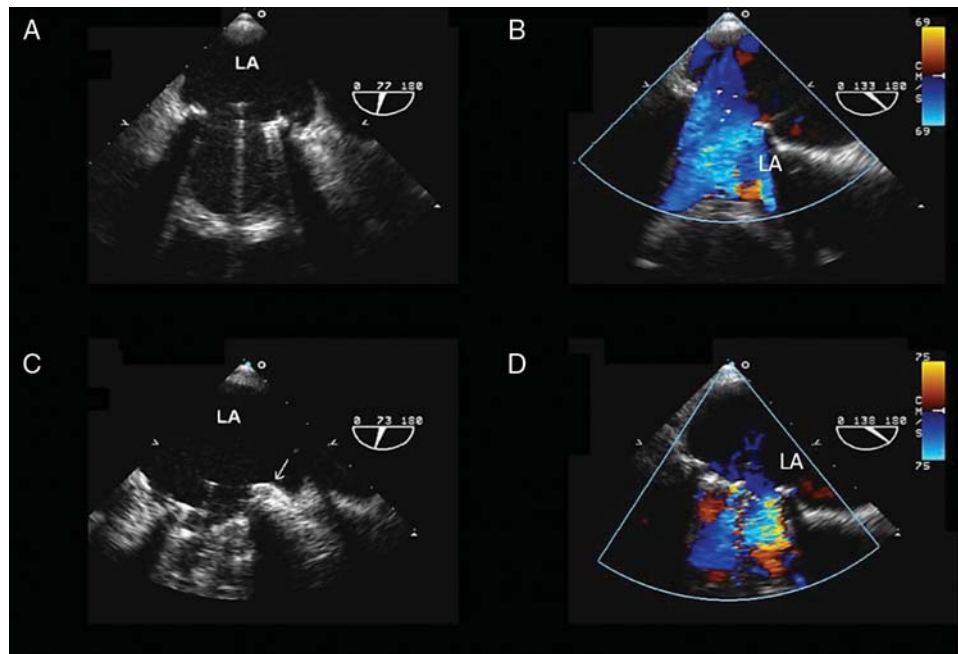

**Figure 26** Transoesophageal view in diastole before the procedure shows full opening of the disc of a mitral single leaflet mechanical valve (A), with no limitation to flow on colour-flow imaging (B). Following the implantation of an occluder device (arrow), the disc motion is restricted (C), and colour-flow imaging shows turbulent transvalvular flow (D). LA, left atrium.

closure device, TEE helps to ensure proper positioning of the opened occluder over the paravalvular defect and proper seating of the device (Figure 20C and D). Simultaneously, function of the prosthetic valve, particularly if this is a mechanical prosthesis, should be assessed to ensure that the occluder does not impede proper opening and closing of the prosthetic leaflets/discs (Figure 26). With mechanical prosthetic valves, fluoroscopy should also be used to assess the motion of the leaflet(s).<sup>58,62</sup> The occluder device is not released until proper device seating and prosthetic valve function are assured. After release of the device, TEE is performed to assess residual PVR, which is not uncommon after the procedure (Figure 27D). If the residual regurgitation is severe, placement of additional devices can be considered (Figure 28). Other complications such as air embolism and haemopericardium can also be readily detected by TEE.<sup>57,58</sup>

## Percutaneous mitral valve intervention

### Introduction

MR is an important cause of morbidity and mortality in developed countries.<sup>64,65</sup> The most common causes of MR are degenerative and functional (ischaemic and non-ischaemic), with an age-related epidemiological burden consisting of a peak incidence in patients over 70 years of age.<sup>64</sup> Open surgical correction, using mitral valve repair or replacement, is currently accepted as the best available treatment of MR.<sup>21</sup> However, there is a need for alternative treatment options. For example, a significant number of patients

with severe MR are denied surgery on the basis of age, LV dysfunction, and/or co-morbidities.<sup>66</sup> The survival rate of these non-operated patients is lower than that of those who undergo surgery. In addition, patients with less-than-severe MR that is uncorrected at the time of first cardiac surgery may develop significant MR over time and be denied reoperation on the basis of increased risk. In clinical practice, the presence of severe MR has favoured surgical over percutaneous revascularization in those with coronary artery disease, because of the need to perform concomitant mitral repair/replacement but access to transcatheter treatment of MR might permit simultaneous transcatheter revascularization and mitral repair as an alternative to surgery. Finally, some patients might need prophylactic MR correction in order to tolerate potentially high-risk therapies for non-cardiac disease. Thus, substantial efforts have been made to carry out less invasive mitral valve repair using various percutaneous strategies with the goals of decreasing morbidity and mortality and offering repair to patients at high risk for surgery.<sup>67</sup>

As with surgical mitral repair, the echocardiographic assessment of mitral functional anatomy and the determination of the mechanism of MR are mandatory to select patients who can benefit from percutaneous intervention and to tailor the repair strategy. Both degenerative and functional/ischaemic MR can be suitable for percutaneous valve repair through a variety of approaches including those that offer direct leaflet repair, direct or indirect annular remodelling, and ventricular remodelling. Two-dimensional echocardiography supplemented by a real-time 3D imaging is also essential to guide and evaluate the effectiveness of the chosen percutaneous repair technique.

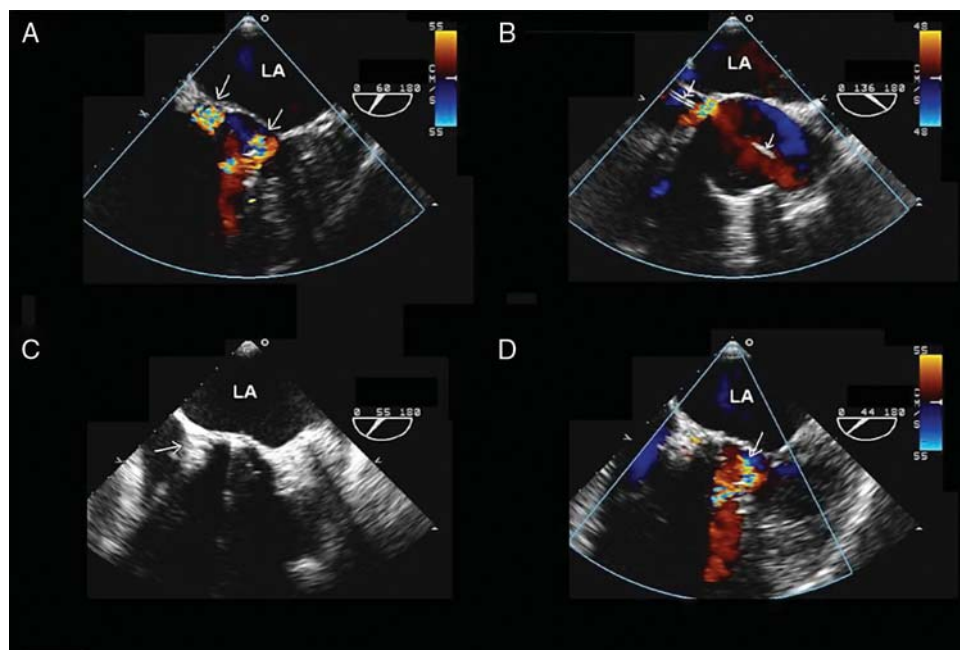

**Figure 27** (A) Transoesophageal colour-flow imaging of an aortic mechanical bileaflet valve in short-axis shows two paravalvular regurgitant jets (arrows). (B) The guide wire (arrows) has been passed through the posterior dehiscence. (C) The occluder device (arrow) is deployed. (D) The posterior paravalvular regurgitant is no longer present, but the anterior regurgitant jet is again detected. LA, left atrium.

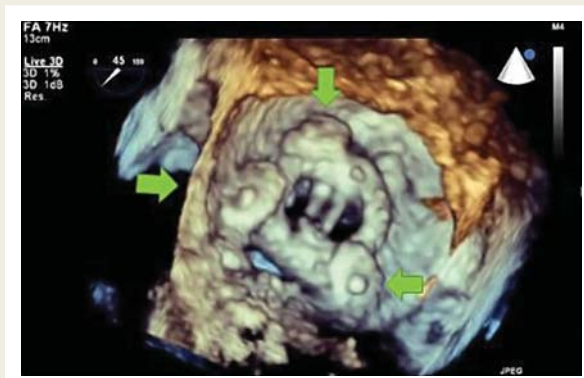

**Figure 28** Three-dimensional transoesophageal echocardiography image from a left atrial perspective demonstrating three closure devices (arrows) surrounding a bileaflet mitral prosthesis.

## Percutaneous therapies and current experience

Percutaneous repair techniques can be categorized into four general approaches, the majority patterned on surgical interventions:

- (i) Indirect annuloplasty-coronary sinus techniques
- (ii) Direct annuloplasty
- (iii) Leaflet repair
- (iv) Ventricular remodelling

Table 3 summarizes the clinical experience with available devices for percutaneous mitral valve repair. However, it should be noted that this is a rapidly changing field with the frequent introduction of new devices and withdrawal/redesign of existing devices. Thus, subsequent paragraphs will focus on general principles of echocardiographic evaluation of the mitral valve that are applicable to all devices with a detailed discussion of procedural echocardiography limited to the MitraClip™. This device has been most extensively evaluated and is, consequently, the only device with CE mark and the only device (while still investigational) that has completed pivotal trial evaluation and is available for compassionate use in the USA.

### Percutaneous annuloplasty techniques

Percutaneous annuloplasty techniques mimic surgical annular remodelling in order to reverse mitral leaflet coaptation abnormalities and related MR. This approach is targeted to selected patients with functional/ischaemic MR and may be more effective when annular dilation/deformation is predominant. Based on surgical annuloplasty experience, common MR mechanisms that might be corrected by percutaneous annuloplasty include symmetrical leaflet tethering due to LV remodelling or leaflet coaptation loss arising from annular dilation. Hypothetically, patients with extreme asymmetrical tethering (especially when the posterior leaflet shows a tethering angle  $\geq 45^\circ$ ) might not be suitable for percutaneous annuloplasty.<sup>68</sup> However, an analysis of treatment failures with individual devices using detailed 3D echocardiographic imaging will be essential to identify better the subset of patients for whom device therapy might be most suitable. MR arising from structural mitral valve abnormalities, including prolapse/flail

**Table 3** Approaches to percutaneous mitral repair

Approach	Device	Manufacturer	Clinical experience
Coronary sinus annuloplasty <sup>69</sup>	MONARC CARILLON PTMA	Edward Lifesciences Cardiac Dimension Viacor	EVOLUTION I and II trials with core-lab evaluation <sup>a</sup> AMADEUS trial PTOLEMY trial
Direct annuloplasty <sup>70</sup>	QuantumCor Accucinch Percutaneous Annuloplasty System	QuantumCor Guided Delivery Mitralign	Pre-clinical testing Pre-clinical testing First-in-man cases performed
Ventricular remodelling <sup>71,72,75</sup>	iCoapsys	Myocor	First-in-man cases performed
Leaflet repair <sup>77</sup>	MitraClip Mobius	Evalve Edwards Lifesciences	EVEREST I–II trial with core-lab evaluation Clinical studies without core-lab evaluation

<sup>a</sup>EVOLUTION II trial suspended.

for ruptured chordae tendinae, fibrotic or calcified leaflet restriction, or annular calcification, should not be considered for this procedure.

#### Indirect annuloplasty-coronary sinus techniques

Coronary sinus annuloplasty attempts to re-shape the anteroposterior annular dimension to correct the mitral leaflet apposition–coaptation abnormality underlying the MR. The rationale of this approach is based on the anatomical relationship between the coronary sinus/great cardiac vein and the posterior annulus. Several techniques (Table 3) have been proposed that involve placing a device within the coronary sinus/great cardiac vein to attempt septal–lateral diameter reduction and/or mitral annulus ‘cinching’. To achieve therapeutic goals, transcatheter approaches should provide an appropriate degree of tension to reduce MR without slipping and fracturing. The variable distance between the coronary sinus and the mitral annulus, as demonstrated by CT studies, may affect procedural success. In some patients, the coronary sinus is located above the annular level in contact with the left atrial wall. Annular devices in these patients theoretically would cinch the left atrial wall without annular re-shaping and therefore might not reduce MR. An additional concern of indirect annuloplasty is the risk of coronary ischaemic events due to the close but variable relationship between the coronary sinus and the left circumflex artery.<sup>69</sup> Finally, these devices pose at least a theoretical risk of coronary sinus thrombosis or rupture.

#### Direct annuloplasty

Some devices have proposed to remodel the annulus using a direct ventricular approach. Approaches used, to date, have included collagen shrinkage through the application of radiofrequency,<sup>70</sup> and transventricular suture annuloplasty.

#### Mitral leaflet repair

Percutaneous mitral leaflet repair aims to reproduce surgical techniques of improving leaflet coaptation and reducing/eliminating MR. The tested edge-to-edge Alfieri surgical technique<sup>71,72</sup> is mimicked by the percutaneous MitraClip™ system. Other experimental approaches, including chordal replacement or cutting, are currently under development.



**Figure 29** MitraClip™ device for mitral repair. Arms of the device are in the open position.

The MitraClip™ system is a polyester fabric-covered cobalt–chromium implant with two arms which can be opened and closed with a steerable-guiding mechanism (Figure 29).

The MitraClip™ is easily imaged with TEE permitting reliable step-by-step procedural guidance as detailed below. Under general anaesthesia, an antegrade (transseptal) approach is used with the device aligned at the A2–P2 interface perpendicular to the commissure using a sophisticated guiding/positioning system and echocardiographic/fluoroscopic guidance. The device is deployed after successfully grasping the regurgitant target zone of the mitral leaflet. If needed, an additional clip may be placed to achieve satisfactory reduction in MR. The MitraClip™ system



is effective in selected patients with either degenerative or functional MR.

In degenerative MR, the percutaneous clip anchors the flail and/or prolapsed leaflet, whereas, in patients with functional MR, it improves coaptation of the tethered leaflet(s) to reduce the time and force required to close the valve. Additionally, the clip creates a tissue bridge between the two mitral leaflets. As a result, it limits annular dilatation and supports the durability of the repair. Finally, the clip restrains the LV wall by restricting LV dilatation and induces reverse LV remodelling, which, in patients with functional/ischaemic MR, may further reduce tethering and resultant regurgitation.

The procedure has been tested in the safety–feasibility EVEREST I trial that reported procedural success, defined as successful implant with reduced MR  $\leq 2+$ , in 79 of 107 (74%) patients.<sup>73</sup> All results were core-lab-adjudicated. The core-lab-adjudicated randomized controlled EVEREST II trial, comparing percutaneous vs. surgical repair, has recently been reported.<sup>74</sup> In the per-protocol analysis, MitraClip™ therapy was able to reduce MR in 72.4% of patients vs. 87.8% of patients treated surgically. The overall 30-day major adverse event rate (designed to show superiority) in the MitraClip™ arm was similar for both functional and degenerative MR patient subgroups, and both lower than the surgical control group. In addition, the MitraClip™ system demonstrated consistent results in both functional and degenerative MR patients with significant improvement at 1 year from baseline measures of heart function, symptoms, and quality of life, thus meeting the goal of the study to show non-inferiority to surgery. Other recent clinical experiences have been published, providing additional support to the EVEREST data. In a two-centre study, Tamburino *et al.*<sup>75</sup> reported 97% successful implantations in 31 high-risk patients with ischaemic or degenerative MR as defined by the EVEREST criteria. In a single-centre study of 51 subjects at high surgical risk, Franzen *et al.*<sup>76</sup> reported clinical improvement in 49 successfully implanted patients. However, unlike the EVEREST trials, neither of these studies had core-lab evaluation of MR.

Long-term observational studies are needed to confirm the stability of MitraClip™ implantation, sustained MR reduction, and clinical improvement.

#### Ventricular remodelling

Devices based on the concept of ventricular remodelling have been designed in recognition of the fact that abnormal ventricular geometry with displacement of the papillary muscles is an important element in the pathogenesis of functional MR. Although a surgical approach to ventricular remodelling as a treatment for functional MR (Coapsys™) has been evaluated in a core-lab-adjudicated trial and shown to have improved survival and fewer adverse events (although more MR) than the control surgical approach,<sup>77</sup> this and other ventricular remodelling devices remain experimental with meaningful extrapolation to transcatheter approaches yet to come.

### Assessment of the functional anatomy of mitral valve for percutaneous repair

The mitral valve apparatus is a complex anatomic structure composed of the mitral annulus, two discrete leaflets (anterior and

posterior), and chordae which attach both leaflets to anterolateral and posteromedial LV papillary muscles. Importantly, mitral geometry and function are also influenced by the geometry and function of the left atrium and LV. The posterior leaflet is further separated into three discrete, named scallops P1, P2, and P3 (from lateral to medial). Although the anterior mitral leaflet is typically not anatomically divided, its segments are named A1–A3 to mirror the segmentation of the opposing posterior leaflet scallops.

The mitral annulus is a complex saddle-shaped structure with peaks anteriorly and posteriorly, and nadirs medially and laterally. The anterior aspect of the mitral annulus is a rigid fibrous band that is shared with the aorta (aorto-mitral fibrosa or curtain), whereas the remaining medial, lateral, and posterior aspects are more vulnerable to remodelling and distortion of shape.

MR may occur due to diverse clinical and anatomic processes. The pathophysiological triad, a concept first described by Carpentier, separates the ‘disease’ that produces a mitral valve lesion, from the resulting ‘anatomic lesion’ that ensues from that disease, and the subsequent ‘type of valve dysfunction’ that results. Furthermore, Carpentier classified MR into three basic but distinct types of valve dysfunction. Type I dysfunction is characterized by normal mitral leaflet motion and is typically seen in atrial fibrillation with atrial and mitral annular dilation, as well as in endocarditis with valve perforation. Type II dysfunction is characterized by excessive systolic leaflet motion and is seen in degenerative mitral valve disease with prolapse and/or flail of the mitral leaflets. Type IIIa dysfunction is characterized by reduced leaflet motion in both systole and diastole as is seen in rheumatic mitral disease and Type IIIb dysfunction is characterized by reduced systolic leaflet motion, as is typically seen in patients with dilated cardiomyopathy or MR due to ischaemic LV remodelling.

#### Considerations for edge-to-edge repair

Percutaneous edge-to-edge repair may be accomplished with an implantable clip MitraClip™ that approximates the middle scallops of the mitral valve, creating a double orifice mitral valve. As such, the predominant mechanism of MR must originate from the central mitral scallops, A2 and P2. The guidelines for selection of patients for MitraClip™ mirror the selection criteria used in the two EVEREST trials. Patients with degenerative MR (Carpentier Type II dysfunction) with either prolapse or flail of the A2 and/or P2 scallops are candidates for the MitraClip™, and in EVEREST II, represented approximately two-thirds of those evaluated. Similarly, patients with functional MR, either due to dilated cardiomyopathy or ischaemic LV remodelling, are also candidates provided the dominant MR jet arises from A2 to P2. In EVEREST II, these patients accounted for one-third of those enrolled. In EVEREST II, patients with significant MR originating from the medial or lateral aspects of the valve were excluded, as were those with rheumatic disease, endocarditis, and a mitral valve area of  $< 4 \text{ cm}^2$ . Relative contraindications also include abnormal thickness of the leaflets or calcification that would impede grasping by the device arms. Additional functional anatomic exclusions for percutaneous MitraClip™ repair exist. In patients with functional MR, those with a coapting surface length  $< 2 \text{ mm}$  and/or a coaptation depth of  $> 11 \text{ mm}$  are excluded. In patients with degenerative

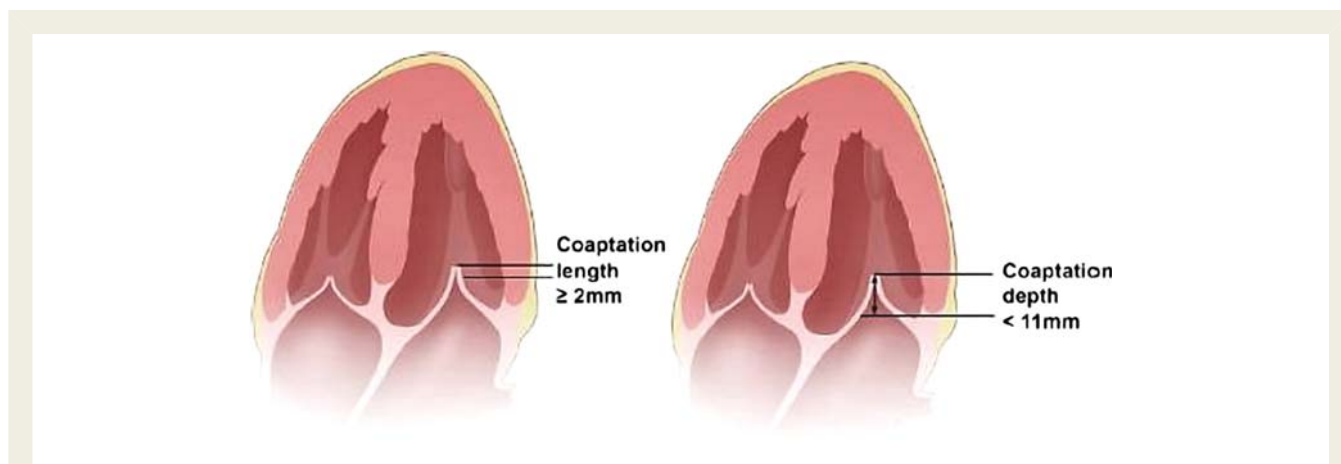

**Figure 30** Schematic representation of the requirements for MitraClip™ in patients with functional mitral regurgitation. Reprinted with permission from Feldman et al.<sup>73</sup>

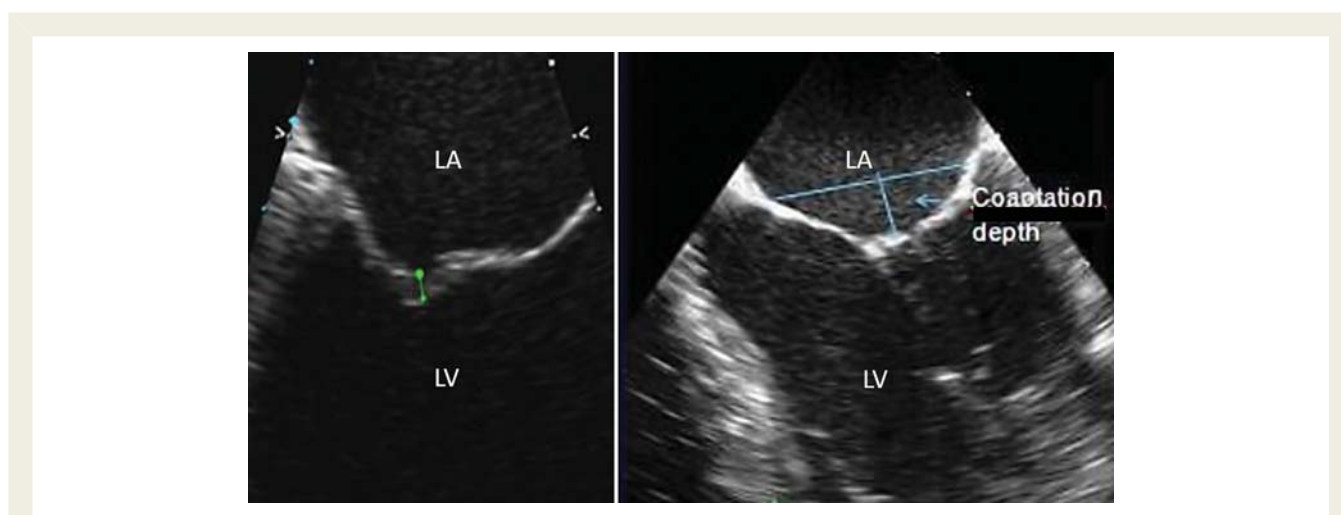

**Figure 31** Transoesophageal echocardiography images depicting measurement of coaptation length (A) and coaptation depth (B). LA, left atrium; LV, left ventricle.

MR, those with a flail height of  $>10$  mm and a flail width of  $>15$  mm are excluded (Figures 30–33).

## Echocardiography for edge-to-edge clip repair

### Patient selection

At present, patient selection involves a consensus between the patients and treating physicians as well as agreement that the patient is anatomically eligible based on TTE and TEE findings.

Clinical indications include:

- (i) Patients who are at high risk for surgery (excessive comorbidity). This may include patients with advanced chronic obstructive airway disease, renal failure, diabetes mellitus, etc.
- (ii) Patients with previous cardiac surgery for whom any re-operation increases the peri-operative risk. This includes patients with functional MR after CABG surgery.
- (iii) Patients who decline surgery.

In addition to confirming the presence of 3–4+ MR using the combined approach recommended by ASE/EAE guidelines,<sup>45</sup> echocardiography is used to determine anatomic suitability for the device. TTE is typically used as an initial screen but TEE, ideally with 3D, is necessary to confirm eligibility.

For patients with functional MR, there needs to be sufficient leaflet tissue for mechanical coaptation. This is evaluated by TEE from the four-chamber view by measuring the coaptation length and depth. As previously noted, for optimal results, coaptation length must be  $\geq 2$  mm and coaptation depth  $\leq 11$  mm (Figure 30). Although an initial assessment may be performed with TTE, these parameters, particularly coaptation length, typically require TEE for precise measurement (Figure 31).

For patients with flail mitral valves, the TEE view should be aligned to demonstrate the maximal excursion of the flail segment [typically mid-oesophageal zero degree angulated to show the A2–P2 scallops and/or the long-axis view of the LVOT

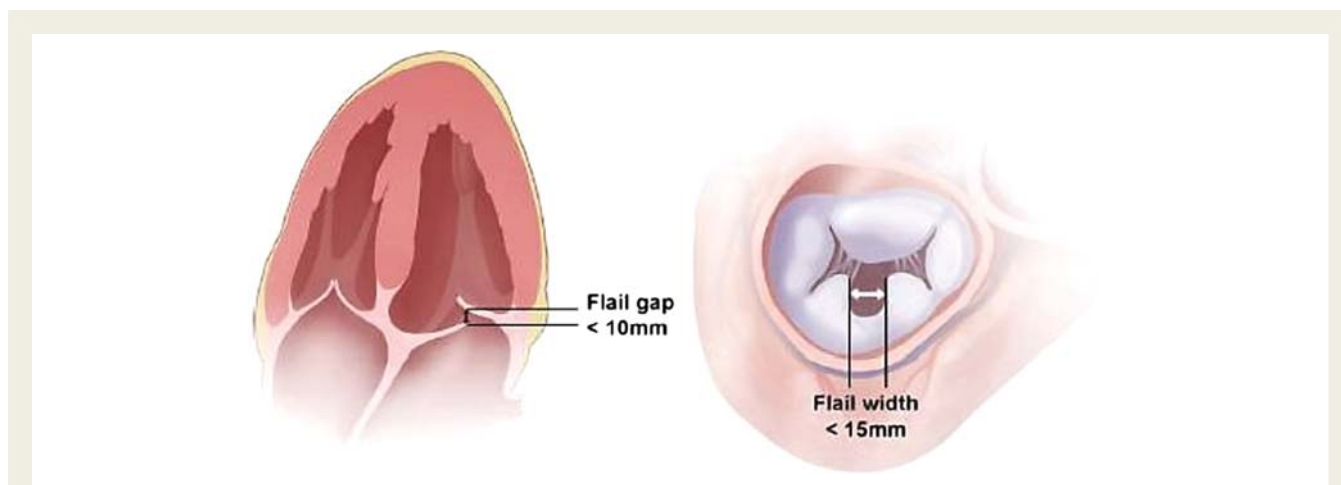

**Figure 32** Schematic showing key measurements in selecting patients with mitral flail for MitraClip™. Reprinted with permission from Feldman et al.<sup>73</sup>

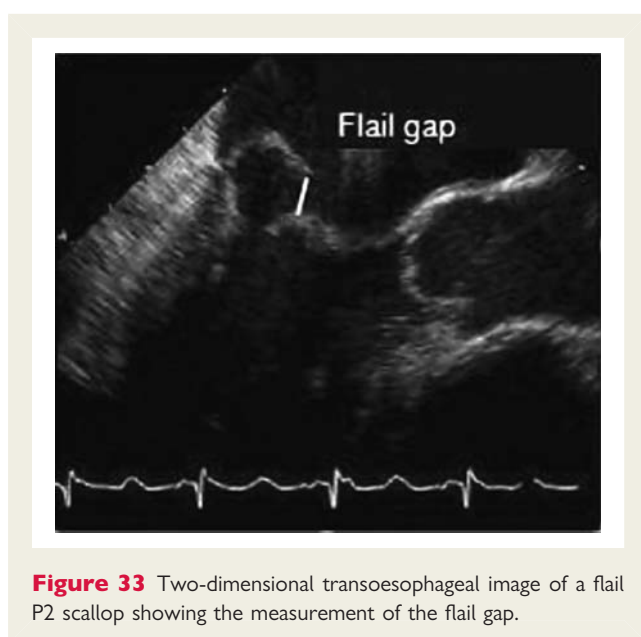

**Figure 33** Two-dimensional transoesophageal image of a flail P2 scallop showing the measurement of the flail gap.

(100–160°) that also shows these scallops]. The inter-commissural view (55–75°) may also be helpful. The distance separating the tip of the flail segment from its opposing normally coapting leaflet is termed as the flail gap. Leaflet grasping is facilitated when this distance is <10 mm (Figures 32 and 33). This measurement is readily accomplished with 2D TEE.

Although 3D TEE provides the clearest delineation of the involved segment with *en face* views from the left atrial perspective, 3D quantitation is limited since there is no calibration of these views. However, adequate sizing can be achieved using the inter-commissural 2D view with complementary information available in some patients using the transgastric short-axis view of the valve. The flail/prolapse width should be <15 mm.

TTE ± TEE will also identify patients whose regurgitation is on the basis of rheumatic disease or endocarditis or who have other anatomic exclusions as described previously.

### Peri-procedural echocardiography

Echocardiography is the primary imaging modality used at all stages of the percutaneous mitral clip procedure, complementing fluoroscopy.<sup>78</sup>

#### Transseptal catheterization

During the transseptal puncture, TEE is helpful in guiding precise positioning of the transseptal catheter, first in puncturing the atrial septum and second in positioning the MitraClip™ guiding catheter. The primary views are the mid-oesophageal short-axis view (30–60°) and bicaval 90° view at the level of the aortic valve. These can be simultaneously displayed with biplane imaging using 3D probes. The transseptal puncture should be performed through the posterior-mid aspect of the fossa in a posterior and superior direction. This is to facilitate the ultimate positioning of the clip delivery system. During transseptal puncture, TEE identifies the position of the needle tip by detecting the tenting it creates on the adjacent septum rather than on the basis of directly imaging the needle tip. The puncture site should sit 3.5–4.0 cm above the leaflets. If the position of the catheter is suboptimal, the needle may be repositioned prior to puncturing the septum.

#### Advancing the clip delivery system towards the mitral leaflets

Once the correct transseptal puncture has been made, the mitral clip delivery system is angled down towards the mitral leaflets, aiming for A2–P2. Correct positioning can be ascertained from the inter-commissural (55–75°) projection demonstrating medial–lateral alignment and the LV outflow (100–160°) projection demonstrating posterior–anterior alignment. Three-dimensional TEE (3D zoom with a large field of view) greatly facilitates this part of the procedure as it provides an *en face* view of the mitral leaflets and approaching clip (Figure 34).

### Positioning the clip above the regurgitant orifice and orientation of the clip arms

The optimal position of the clip delivery system is immediately above the regurgitant orifice, which will be the target of the clip. The target orifice is chosen using the maximal PISA effect. The clip should be oriented perpendicular to the commissure, something easily assessed with 3D zoom imaging. However, if 3D is not available, the transgastric short-axis view may be used for this purpose.

### Entry into the left ventricle and pull-back to grasp the leaflets

As viewed from the LVOT position (100–160°), the clip with the arms closed will cross the mitral leaflets and enter the LV. Here, 3D echo (or alternatively the transgastric short-axis view)

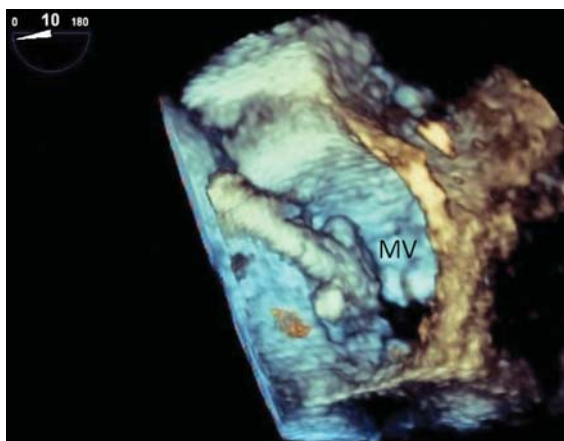

**Figure 34** Three-dimensional transoesophageal echocardiography image from the left atrial perspective showing the MitraClip™ delivery system directed towards the mitral orifice. Real-time three-dimensional imaging greatly facilitates the process of ensuring that the clip is appropriately directed/aligned. MV, mitral valve.

permits a rapid check that the arms of the mitral clip device are still perpendicular to the line of coaptation as the delivery system may rotate as it is advanced.

Once the delivery system is in the LV, the clip arms open and the device is pulled back towards the left atrium, simultaneously grasping both leaflets with the device grippers (*Figure 35*). Using the LV outflow and inter-commissural views (60–70°), capture of both leaflets must be verified and the clip closed. If either leaflet is inadequately captured, the clip is reopened and re-advanced into the LV and the process is repeated. Once both leaflets have been satisfactorily clipped, a quick assessment of residual MR with colour Doppler is performed. Additionally, it is essential to exclude mitral stenosis, particularly if two clips have been deployed. This is accomplished by measuring the transvalvular gradient with continuous-wave Doppler and planimetry of the two orifices using ideally 3D or alternatively transgastric short-axis views. If MR reduction is satisfactory and the degree of stenosis is acceptable (mean gradient  $\leq 5$  mmHg), the clip is fully deployed by detaching it from the delivery system. At this point, a final assessment of MR is performed.<sup>79</sup>

If there is significant residual regurgitation and the source of the residual regurgitation is amenable to correction with a second clip, a second clip may be placed using a similar overall approach but using the first clip as a reference point. In assessing the degree of residual MR, it is important that the systolic blood pressure approximate normal values for the patient as functional MR, in particular, is afterload-dependent.

Using 3D echocardiography, it is possible to observe the repaired valve *en face* from both atrial (*Figure 36*) and ventricular perspectives, documenting the eccentricity, if any, of the dual orifices created by the device. Moreover, 3D colour displays also provide good definition of the site(s) of any residual regurgitation (*Figure 37*).

### Detection of complications

TEE provides a method for early detection of many of the potential complications of clip placement including perforation of the atrial wall, resulting in pericardial effusion, partial dehiscence of the

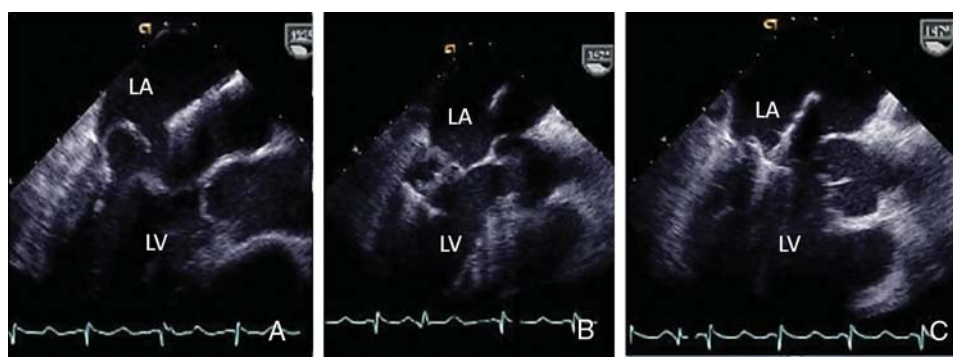
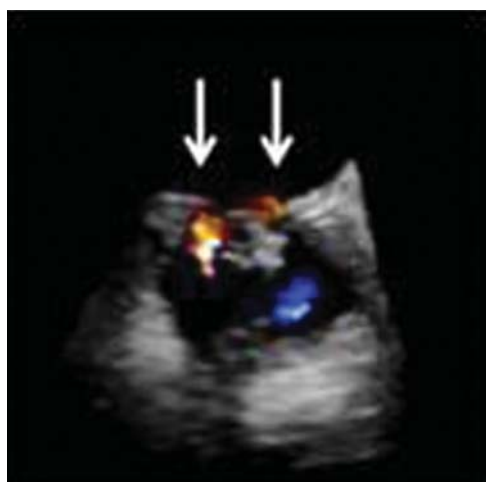

**Figure 35** Two-dimensional transoesophageal echocardiography images showing the left ventricular outflow tract view used to monitor advancement of the MitraClip™ delivery system across the mitral valve (A), opening of the clip arms (B), and pull back across the valve with closure of the device arms to grasp the free edges of A2 and P2 (C). LA, left atrium; LV, left ventricle.

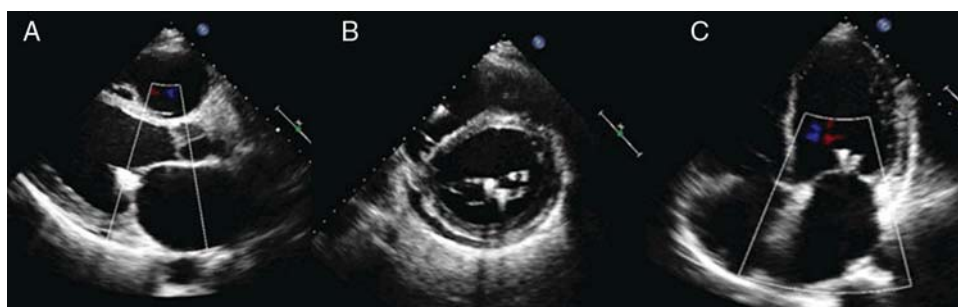



**Figure 36** Three-dimensional transoesophageal echocardiography view of the typical double orifice appearance of a mitral valve that has undergone successful MitraClip™ placement (atrial perspective).



**Figure 37** Three-dimensional transoesophageal echocardiography view from the left atrial perspective showing two small jets of residual mitral regurgitation (arrows).



**Figure 38** Parasternal long-axis (A), parasternal short-axis (B) and apical four-chamber (C) views showing successfully placed MitraClip™. In this case, two clips were needed to eliminate the mitral regurgitation.

clip after initial seating and leaflet or chordal tears caused by repeated attempts to grasp the leaflets.

## Echocardiography for outpatient follow-up

Follow-up of patients after successful mitral clip placement is important. Key elements of echocardiographic follow-up are described below.

### Assessing the presence of residual/recurrent mitral regurgitation

Although TEE is best suited for assessing MR, a careful transthoracic examination may be sufficient. Quantitation of any residual MR may be difficult as the mitral valve will now have two orifices and the mitral inflow volume needed for volumetric (quantitative) Doppler calculations cannot be obtained. Additionally, the PISA approach has not been validated for multiple jets as may exist post MitraClip™ or for the double orifice geometry created with this device. Theoretically, in the absence of aortic regurgitation, LV forward flow can be calculated as flow through the outflow tract using the continuity equation and LV stroke volume calculated from 3D determinations of end-diastolic and end-systolic volumes. The difference between the two (stroke volume – forward flow) = regurgitant volume. In practice, colour Doppler echocardiography using semi-quantitative techniques based on regurgitant jet dimensions and/or the use of 3D TEE to planimeter regurgitant orifices may be best suited for long-term follow-up. As with native valve regurgitation, an integrated approach is essential.<sup>45</sup>

### Assessment of reverse left ventricular remodelling

Following reduction in MR, it is expected that the LV dimensions and volumes will be reduced. Although the timing of LV remodelling in this setting is unclear, a 6-month assessment with TTE is reasonable.

Representative images from transthoracic studies performed after successful MitraClip™ placement are shown in Figure 38.

## Conclusions

Although transcatheter intervention for valvular heart disease is a rapidly evolving field, echocardiography has played and will continue to play a pivotal role. It is notable that the history of echocardiographic imaging during cardiac interventions has been characterized by a transition of responsibility for imaging from echocardiographers to interventionalists (transcatheter procedures) or anaesthesiologists (surgical procedures) with cardiologist–echocardiographers ultimately serving a more consultative, supportive role during the actual procedures. Improved ICE devices would facilitate ultrasound imaging by interventionalists and reduce the demand for general anaesthesia. However, it is notable that when there are intra-procedural complications, patients may need the undivided attention of interventionalists and anaesthesiologists and it may be beneficial to have other physicians available who can focus on imaging. Although these recommendations have been designed with the non-invasive cardiologist–echocardiographer in mind, they should be equally valuable to anaesthesiologists and interventionalists who may become involved in imaging patients undergoing transcatheter valve procedures.

**Conflict of interest:** The following authors reported relationships with one or more commercial interests: L.P.B. has served on the board of speakers and received research grants from GE Healthcare and is a member of the Clinical Event Committee for Edwards Lifesciences; C.B. owns stock in Edwards Lifesciences; L.D.G. directs core labs which have contracts with Edwards Lifesciences; M.J.M. has served on the speaker's bureau for Edwards Lifesciences and Philips Medical Systems; P.N. has received research grants from Bracco and GE Healthcare; J.-L.V. has served as a consultant for Philips Medical Systems and Edwards Lifesciences.

## References

1. Silvestry FE, Kerber RE, Brook MM, Carroll JD, Eberman KM, Goldstein SA et al. Echocardiography-guided interventions. *J Am Soc Echocardiogr* 2009;**22**:213–31.
2. Cribier A, Eltchaninoff H, Bash A, Borenstein N, Tron C, Bauer F et al. Percutaneous transcatheter implantation of an aortic valve prosthesis for calcific aortic stenosis: first human case description. *Circulation* 2002;**106**:3006–8.
3. Lichtenstein SV, Cheung A, Ye J, Thompson CR, Carere RG, Pasupati S et al. Transapical transcatheter aortic valve implantation in humans: initial clinical experience. *Circulation* 2006;**114**:591–6.
4. Grube E, Laborde JC, Zickmann B, Gerckens U, Felderhoff T, Sauren B et al. First report on a human percutaneous transluminal implantation of a self-expanding valve prosthesis for interventional treatment of aortic valve stenosis. *Catheter Cardiovasc Interv* 2005;**66**:465–9.
5. Leon MB, Smith CR, Mack M, Miller DC, Moses JW, Svensson LG et al. Transcatheter aortic-valve implantation for aortic stenosis in patients who cannot undergo surgery. *N Engl J Med* 2010;**363**:1597–607.
6. Grube E, Schuler G, Buellesfeld L, Gerckens U, Linke A, Wenaweser P et al. Percutaneous aortic valve replacement for severe aortic stenosis in high-risk patients using the second- and current third-generation self-expanding corevalve prosthesis: device success and 30-day clinical outcome. *J Am Coll Cardiol* 2007;**50**:69–76.
7. Smith CR, Leon MB, Mack MJ, Miller DC, Moses JW, Svensson LG et al. Transcatheter versus Surgical Aortic-Valve Replacement in High-Risk Patients. *N Engl J Med* 2011;**364**:2187–2198.
8. Webb JG, Chandavimol M, Thompson CR, Ricci DR, Carere RG, Munt BI et al. Percutaneous aortic valve implantation retrograde from the femoral artery. *Circulation* 2006;**113**:842–50.
9. Zajarias A, Cribier AG. Outcomes and safety of percutaneous aortic valve replacement. *J Am Coll Cardiol* 2009;**53**:1829–36.
10. Thomas M, Schymik G, Walther T, Himbert D, Lefevre T, Treede H et al. Thirty-day results of the SAPIEN Aortic Bioprosthesis European Outcome (SOURCE) registry: a European registry of transcatheter aortic valve implantation using the Edwards SAPIEN valve. *Circulation* 2010;**122**:62–9.
11. Webb JG, Altwegg L, Boone RH, Cheung A, Ye J, Lichtenstein S et al. Transcatheter aortic valve implantation: impact on clinical and valve-related outcomes. *Circulation* 2009;**119**:3009–16.
12. Lange R, Schreiber C, Gotz W, Hettich I, Will A, Libera P et al. First successful transapical aortic valve implantation with the Corevalve Revalving system: a case report. *Heart Surg Forum* 2007;**10**:E478–9.
13. Piazza N, Grube E, Gerckens U, den Heijer P, Linke A, Luha O et al. Procedural and 30-day outcomes following transcatheter aortic valve implantation using the third generation (18 Fr) corevalve revalving system: results from the multicentre, expanded evaluation registry 1-year following CE mark approval. *EuroIntervention* 2008;**4**:242–9.
14. Vahanian A, Alfieri OR, Al-Attar N, Antunes MJ, Bax J, Cormier B et al. Transcatheter valve implantation for patients with aortic stenosis: a position statement from the European Association of Cardio-Thoracic Surgery (EACTS) and the European Society of Cardiology (ESC), in collaboration with the European Association of Percutaneous Cardiovascular Interventions (EAPCI). *Eur J Cardiothorac Surg* 2008;**34**:1–8.
15. Osswald BR, Gegouskov V, Badowski-Zyla D, Tochtermann U, Thomas G, Hagl S et al. Overestimation of aortic valve replacement risk by EuroSCORE: implications for percutaneous valve replacement. *Eur Heart J* 2009;**30**:74–80.
16. Rodes-Cabau J, Webb JG, Cheung A, Ye J, Dumont E, Feindel CM et al. Transcatheter aortic valve implantation for the treatment of severe symptomatic aortic stenosis in patients at very high or prohibitive surgical risk: acute and late outcomes of the multicenter Canadian experience. *J Am Coll Cardiol* 2010;**55**:1080–90.
17. Zegdi R, Ciobotaru V, Noghin M, Sleilaty G, Lafont A, Latrémouille C et al. Is it reasonable to treat all calcified stenotic aortic valves with a valved stent? Results from a human anatomic study in adults. *J Am Coll Cardiol* 2008;**51**:579–84.
18. Delgado V, Tops LF, Schuijff JD, van der Kley F, van de Veire NR, Schalij MJ et al. Successful deployment of a transcatheter aortic valve in bicuspid aortic stenosis: role of imaging with multislice computed tomography. *Circ Cardiovasc Imaging* 2009;**2**:e12–3.
19. Baumgartner H, Hung J, Bermejo J, Chambers JB, Evangelista A, Griffin BP et al. Echocardiographic assessment of valve stenosis: EAE/ASE recommendations for clinical practice. *Eur J Echocardiogr* 2009;**10**:1–25.
20. Bonow RO, Carabello BA, Chatterjee K, de Leon AC Jr, Faxon DP, Freed MD et al. 2008 focused update incorporated into the ACC/AHA 2006 guidelines for the management of patients with valvular heart disease: a report of the American College of Cardiology/American Heart Association Task Force on Practice Guidelines (Writing Committee to revise the 1998 guidelines for the management of patients with valvular heart disease). Endorsed by the Society of Cardiovascular Anesthesiologists, Society for Cardiovascular Angiography and Interventions, and Society of Thoracic Surgeons. *J Am Coll Cardiol* 2008;**52**:e1–142.
21. Vahanian A, Baumgartner H, Bax J, Butchart E, Dion R, Filippatos G et al. Guidelines on the management of valvular heart disease. *Eur Heart J* 2007;**28**:230–68.
22. Grayburn PA. Assessment of low-gradient aortic stenosis with dobutamine. *Circulation* 2006;**113**:604–6.
23. Blais C, Burwash IG, Mundigler G, Dumesnil JG, Loho N, Rader F et al. Projected valve area at normal flow rate improves the assessment of stenosis severity in patients with low-flow, low-gradient aortic stenosis: the multicenter TOPAS (Truly or Pseudo-Severe Aortic Stenosis) study. *Circulation* 2006;**113**:711–21.
24. Piazza N, De Jaegere P, Schultz C, Becker AE, Serruys PW, Anderson RH. Anatomy of the aortic valvar complex and its implications for transcatheter implantation of the aortic valve. *Circ Cardiovasc Interv* 2008;**1**:74–81.
25. Vivas D, Perez de Isla L, Zamorano J. Using echocardiography to guide interventional procedures. *Curr Cardiovasc Imaging Rep* 2008;**1**:9–15.
26. Messika-Zeitoun D, Serfaty JM, Brochet E, Ducrocq G, Lepage L, Detaint D et al. Multimodal assessment of the aortic annulus diameter: implications for transcatheter aortic valve implantation. *J Am Coll Cardiol* 2010;**55**:186–94.
27. Van de Veire N. Imaging to guide transcatheter aortic valve implantation. *J Echocardiogr* 2010;**8**:1–6.
28. Spencer KT, Krauss D, Thurn J, Mor-Avi V, Poppas A, Vignon P et al. Transnasal transesophageal echocardiography. *J Am Soc Echocardiogr* 1997;**10**:728–37.
29. Spencer KT, Goldman M, Cholley B, Hultman J, Oropello J, Harris K et al. Multi-center experience using a new prototype transnasal transesophageal echocardiography probe. *Echocardiography* 1999;**16**:811–7.
30. Rallidis LS, Moysakis IE, Ikonomidis I, Nihoyannopoulos P. Natural history of early aortic paraprosthesis regurgitation: a five-year follow-up. *Am Heart J* 1999;**138**:351–7.
31. Detaint D, Lepage L, Himbert D, Brochet E, Messika-Zeitoun D, Lung B et al. Determinants of significant paravalvular regurgitation after transcatheter aortic

- valve implantation: impact of device and annulus incongruence. *JACC: Cardiovasc Interv* 2009;**2**:821–7.
32. Lancellotti P, Tribouilloy C, Hagendorff A, Moura L, Popescu BA, Agricola E et al. European Association of Echocardiography recommendations for the assessment of valvular regurgitation. Part 1: aortic and pulmonary regurgitation (native valve disease). *Eur J Echocardiogr* 2010;**11**:223–44.
  33. Zoghbi WA, Chambers JB, Dumesnil JG, Foster E, Gottdiener JS, Grayburn PA et al. Recommendations for evaluation of prosthetic valves with echocardiography and Doppler ultrasound: a report from the American Society of Echocardiography's Guidelines and Standards Committee and the Task Force on Prosthetic Valves, developed in conjunction with the American College of Cardiology Cardiovascular Imaging Committee, Cardiac Imaging Committee of the American Heart Association, the European Association of Echocardiography, a registered branch of the European Society of Cardiology, the Japanese Society of Echocardiography and the Canadian Society of Echocardiography, endorsed by the American College of Cardiology Foundation, American Heart Association, European Association of Echocardiography, a registered branch of the European Society of Cardiology, the Japanese Society of Echocardiography, and Canadian Society of Echocardiography. *J Am Soc Echocardiogr* 2009;**22**:975–1014.
  34. Gonçalves A, Marcos-Alberca P, Zamorano JL. Echocardiography: guidance during valve implantation. *EuroIntervention* 2010;**6**:g14–9.
  35. Moss RR, Ivens E, Pasupati S, Humphries K, Thompson CR, Munt B et al. Role of echocardiography in percutaneous aortic valve implantation. *JACC: Cardiovasc Imaging* 2008;**1**:15–24.
  36. Tuzcu EM. Transcatheter aortic valve replacement malposition and embolization: innovation brings solutions also new challenges. *Catheter Cardiovasc Interv* 2008;**4**: 579–80.
  37. de Isla LP, Rodriguez E, Zamorano J. Transapical aortic prosthesis malplacement. *J Am Coll Cardiol* 2008;**52**:2043.
  38. Walther T, Falk V, Kempfert J, Borger MA, Fassl J, Chu MWA et al. Transapical minimally invasive aortic valve implantation; the initial 50 patients. *Eur J Cardiothorac Surg* 2008;**33**:983–8.
  39. Yan TD, Cao C, Martens-Nielsen J, Padang R, Ng M, Valley MP et al. Transcatheter aortic valve implantation for high-risk patients with severe aortic stenosis: a systematic review. *J Thorac Cardiovasc Surg* 2010;**139**:1519–28.
  40. Berry C, Cartier R, Bonan R. Fatal ischemic stroke related to nonpermissive peripheral artery access for percutaneous aortic valve replacement. *Catheter Cardiovasc Interv* 2007;**69**:56–63.
  41. Masson JB, Kovac J, Schuler G, Ye J, Cheung A, Kapadia S et al. Transcatheter aortic valve implantation: review of the nature, management, and avoidance of procedural complications. *JACC: Cardiovasc Interv* 2009;**2**:811–20.
  42. Bleiziffer S, Ruge H, Horer J, Hutter A, Geisbnsch S, Brockmann G et al. Predictors for new-onset complete heart block after transcatheter aortic valve implantation. *JACC: Cardiovasc Interv* 2010;**3**:524–30.
  43. Unsworth B, Malik I, Mikhail GW. Recognising bicuspid aortic stenosis in patients referred for transcatheter aortic valve implantation: routine screening with three-dimensional transoesophageal echocardiography. *Heart* 2010;**96**:645.
  44. Shames S, Koczo A, Hahn R, Gillam L. Flow characteristics of the SAPIEN™ aortic valve: the importance of recognizing in-stent flow acceleration for the echocardiographic assessment of valve function. *J Am Soc Echocardiogr* 2011;**24**: B63.
  45. Zoghbi WA, Enriquez-Sarano M, Foster E, Grayburn PA, Kraft CD, Levine RA et al. Recommendations for evaluation of the severity of native valvular regurgitation with two-dimensional and doppler echocardiography. *J Am Soc Echocardiogr* 2003;**16**:777–802.
  46. Pirat B, Little SH, Igo SR, McCulloch M, Nose Y, Hartley CJ et al. Direct measurement of proximal isovelocity surface area by real-time three-dimensional color Doppler for quantitation of aortic regurgitant volume: an in vitro validation. *J Am Soc Echocardiogr* 2009;**22**:306–13.
  47. Grube E, Buellesfeld L, Mueller R, Sauren B, Zickmann B, Nair D et al. Progress and current status of percutaneous aortic valve replacement: results of three device generations of the CoreValve Revalving system. *Circ Cardiovasc Interv* 2008;**1**:167–75.
  48. Webb JG, Altwegg L, Masson JB, Al Bugami S, Al Ali A, Boone RA. A new transcatheter aortic valve and percutaneous valve delivery system. *J Am Coll Cardiol* 2009;**53**:1855–8.
  49. Tamburino C, Barbanti M, Capodanno D, Ussia GP. Transcatheter aortic valve implantations: what has been done and what is going to be done. *Future Cardiol* 2010;**6**:83–95.
  50. Piechaud J. Percutaneous closure of mitral paravalvular leak. *J Interv Cardiol* 2003;**16**:153–5.
  51. Hijazi Z. Transcatheter management of paravalvular mitral leaks: far from ideal. *Catheter Cardiovasc Interv* 2004;**61**:552–3.
  52. Nietlispach F, Johnson M, Moss RR, Wijesinghe N, Gurvitch R, Tay ELW et al. Transcatheter closure of paravalvular defects using a purpose-specific occluder. *JACC: Cardiovasc Interv* 2010;**3**:759–65.
  53. Deferios S, Giannopoulos G, Raisakis K, Kaoukis K, Kossyvakis C. Intracardiac echocardiography imaging of periprosthetic valvular regurgitation. *Eur J Echocardiogr* 2010;**11**:E20.
  54. Hamilton-Craig C, Boga T, Platts D, Walters DL, Burstow DJ, Scalia G. The role of 3D transesophageal echocardiography during percutaneous closure of paravalvular mitral regurgitation. *JACC: Cardiovasc Imaging* 2009;**2**:771–3.
  55. Garcia-Fernandez MA, Cortes M, Garcia-Robles JA, Gomez de Diego JJ, Perez-David E, Garcia E. Utility of real-time three-dimensional transesophageal echocardiography in evaluating the success of percutaneous transcatheter closure of mitral paravalvular leaks. *J Am Soc Echocardiogr* 2010;**23**:26–32.
  56. Hagler DJ, Cabalka AK, Sorajja P, Cetta F, Mankad SV, Bruce CJ et al. Assessment of percutaneous catheter treatment of paravalvular prosthetic regurgitation. *J Am Coll Cardiol Imaging* 2010;**3**:88–91.
  57. Kim MS, Casserly IP, Garcia JA, Klein AJ, Salcedo EE, Carroll JD. Percutaneous transcatheter closure of prosthetic mitral paravalvular leaks: are we there yet? *JACC: Cardiovasc Interv* 2009;**2**:81–90.
  58. Pate G, Thompson CR, Munt BI, Webb JG. Techniques for percutaneous closure of prosthetic paravalvular leaks. *Catheter Cardiovasc Interv* 2010;**67**: 158–66.
  59. Becerra JM, Almeria C, de Isla LP, Zamorano J. Usefulness of 3D transoesophageal echocardiography for guiding wires and closure devices in mitral paravalvular leaks. *Eur J Echocardiogr* 2009;**10**:979–81.
  60. Phillips SA, Thompson A, bu-Halimah A, Crenshaw MH, Zhao DX, Pretorius M. Percutaneous closure of aortic prosthetic paravalvular regurgitation with two Amplatzer septal occluders. *Anesth Analg* 2009;**108**:437–8.
  61. Pate G, Al Zubaidi A, Chandavimol M, Thompson CR, Munt BI, Webb JG. Percutaneous closure of prosthetic paravalvular leaks: case series and review. *Catheter Cardiovasc Interv* 2006;**68**:528–33.
  62. Sorajja P, Cabalka AK, Hagler DJ, Reeder GS, Chandrasekaran K, Cetta F et al. Successful percutaneous repair of paravalvular prosthetic regurgitation. *Catheter Cardiovasc Interv* 2007;**70**:815–23.
  63. Alonso-Briales JH, Muñoz-García AJ, Jiménez-Navarro MF, Domínguez-Franco AJ, Melero-Tejedor JM, Rodríguez-Bailón I et al. Closure of paravalvular leaks using an Amplatzer occluder. *Rev Esp Cardiol* 2009;**62**:442–6.
  64. Nkomo VT, Gardin JM, Skelton TN, Gottdiener JS, Scott CG, Enriquez-Sarano M. Burden of valvular heart diseases: a population-based study. *Lancet* 2006;**368**: 1005–11.
  65. Iung B, Baron G, Butchart EG, Delahaye F, Gohlke-Bärwolf C, Levang OW et al. A prospective survey of patients with valvular heart disease in Europe: the Euro Heart Survey on Valvular Heart Disease. *Eur Heart J* 2003;**24**: 1231–43.
  66. Mirabel M, Iung B, Baron G, Messika-Zeitoun D, Deltaint D, Vanoverschelde JL et al. What are the characteristics of patients with severe, symptomatic, mitral regurgitation who are denied surgery? *Eur Heart J* 2007;**28**:1358–65.
  67. Masson JB, Webb JG. Percutaneous treatment of mitral regurgitation. *Circ Cardiovasc Interv* 2009;**2**:140–6.
  68. Magne J, Pibarot P, Dagenais F, Hachicha Z, Dumesnil JG, Senechal M. Preoperative posterior leaflet angle accurately predicts outcome after restrictive mitral valve annuloplasty for ischemic mitral regurgitation. *Circulation* 2007;**115**:782–91.
  69. Tops LF, van de Veire NR, Schuijff JD, de Roos A, van der Wall EE, Schalij MJ et al. Noninvasive evaluation of coronary sinus anatomy and its relation to the mitral valve annulus: implications for percutaneous mitral annuloplasty. *Circulation* 2007;**115**:1426–32.
  70. Sorajja P, Nishimura RA, Thompson J, Zehr K. A novel method of percutaneous mitral valve repair for ischemic mitral regurgitation. *JACC: Cardiovasc Interv* 2008;**1**: 663–72.
  71. Alfieri O, Maisano F, De Bonis M, Stefano PL, Torracca L, Oppizzi M et al. The double-orifice technique in mitral valve repair: a simple solution for complex problems. *J Thorac Cardiovasc Surg* 2001;**122**:674–81.
  72. De Bonis M, Lapenna E, La Canna G, Ficarra E, Pagliaro M, Torracca L et al. Mitral valve repair for functional mitral regurgitation in end-stage dilated cardiomyopathy: role of the 'edge-to-edge' technique. *Circulation* 2005;**112**:i–402.
  73. Feldman T, Kar S, Rinaldi M, Fail P, Hermiller J, Smalling R et al. Percutaneous mitral repair with the MitraClip system: safety and midterm durability in the initial EVEREST (Endovascular Valve Edge-to-Edge REpair Study) cohort. *J Am Coll Cardiol* 2009;**54**:686–94.
  74. Feldman T. Endovascular Valve Edge-to-Edge Repair study (EVEREST II) randomized clinical trial: primary safety and efficacy endpoints. Presented at American College of Cardiology Congress 2010.



75. Tamburino C, Ussia GP, Maisano F, Capodanno D, La Canna G, Scandura S et al. Percutaneous mitral valve repair with the MitraClip system: acute results from a real world setting. *Eur Heart J* 2010;**31**:1382–9.
76. Franzen O, Baldus S, Rudolph V, Meyer S, Knap M, Koschyk D et al. Acute outcomes of MitraClip therapy for mitral regurgitation in high-surgical-risk patients: emphasis on adverse valve morphology and severe left ventricular dysfunction. *Eur Heart J* 2010;**31**:1373–81.
77. Grossi EA, Patel N, Woo YJ, Goldberg JD, Schwartz CF, Subramanian V et al. Outcomes of the RESTOR-MV Trial (Randomized Evaluation of a Surgical Treatment for Off-Pump Repair of the Mitral Valve). *J Am Coll Cardiol* 2010;**56**:1984–93.
78. Silvestry FE, Rodriguez LL, Herrmann HC, Rohatgi S, Weiss SJ, Stewart WJ et al. Echocardiographic guidance and assessment of percutaneous repair for mitral regurgitation with the Evalve MitraClip: lessons learned from EVEREST I. *J Am Soc Echocardiogr* 2007;**20**:1131–40.
79. Lin BA, Forouhar AS, Pahlevan NM, Anastassiou CA, Grayburn PA, Thomas JD et al. Color Doppler jet area overestimates regurgitant volume when multiple jets are present. *J Am Soc Echocardiogr* 2010;**23**:993–1000.
80. Luigi M. Localization of mitral periprosthetic leaks by transesophageal echocardiography. *AJC* 1992;**69**:276–9.

## IMAGE FOCUS

doi:10.1093/ejehocard/jer074

Online publish-ahead-of-print 2 June 2011

### Mitral annulus and left atrium wall abscess fistulized to the left ventricle

Jesús Zarauza<sup>1\*</sup>, Jose A. Vázquez de Prada<sup>2</sup>, Jose M. Cuesta<sup>1</sup>, Pilar Ortiz<sup>1</sup>, Salvador Diez-Aja<sup>1</sup>, and Juan P. Hernando<sup>1</sup>

<sup>1</sup>Cardiology Unit, Hospital Sierrallana, Torrelavega, Cantabria, Spain and <sup>2</sup>Image Unit, Department of Cardiology, Hospital Valdecilla, Santander, Spain

\* Corresponding author. Tel: +34 942847400, Fax: +34 942847415, Email: [jesus.zarauza@scsalud.es](mailto:jesus.zarauza@scsalud.es)

An 86-year-old woman with a previous bioprosthetic aortic valve replacement was admitted to our hospital with fever and general deterioration. Blood cultures grew *Staphylococcus aureus*. A transthoracic echocardiogram showed gross mitral annulus calcification, a vegetation on the auricular side of the posterior mitral leaflet and moderate mitral regurgitation. The aortic bioprosthesis had previously known mild paravalvular leak and new transvalvular moderate aortic regurgitation. A hypoechoic cavity in the posterior mitral annulus and posterior wall of the left atrium was revealed, suggestive of an abscess (Panel A, arrow). A three-dimensional transesophageal echocardiogram confirmed the presence of a mitral annular abscess, with systolic expansion towards the left atrium wall and nearly total diastolic collapse, fistulizing to the left ventricle through an orifice in the mitral annulus (Panel B–D, orifice = arrows; see Supplementary data online, Videos 1, 2, 3, and 4). Three-dimensional images were essential to correctly diagnose the patient and to assess the anatomical relationship of the abscess.

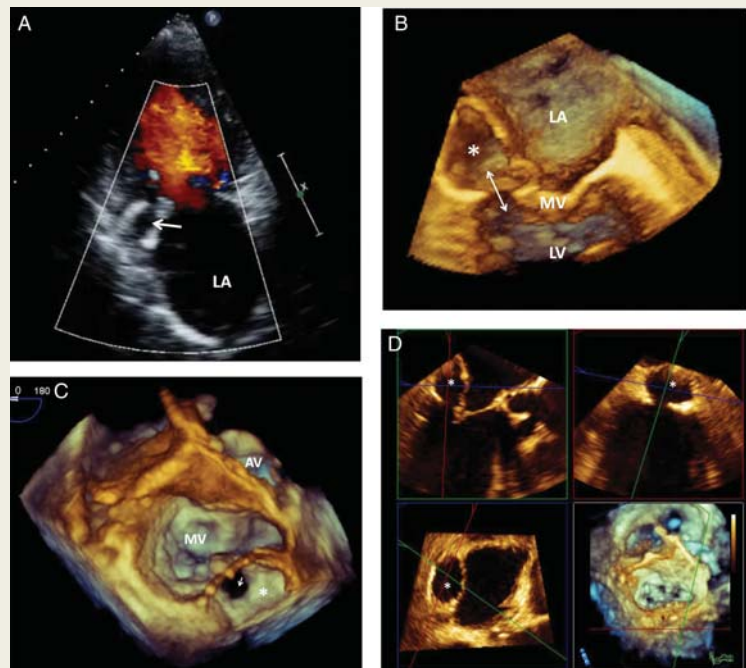

The patient declined surgical treatment and was therefore managed medically. Ten months after being discharged, she remains asymptomatic.

AV, aortic valve; LA, left atrium; LV, left ventricle; \*, abscess.

#### Supplementary data

Supplementary data are available at *European Journal of Echocardiography* online.